



## LISTINO PREZZI

# Prodotti Riabilitativi



**CREHA Riabilitazione di Ortopedia Castagna Srl**

Via Como, 1 - 23896 Bevera di Sirtori (LC)

Tel. +39 0341 372 350- Fax. +39 0341 360 931

[info@creha.it](mailto:info@creha.it) - [www.creha.it](http://www.creha.it)

# INDICE

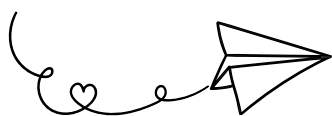

---

<b>5</b>	<b>DEAMBULATORI</b>
<b>7</b>	Buddy Roamer
<b>11</b>	Viaggio <b>[FINE SERIE]</b>
<b>15</b>	<b>IGIENE PERSONALE</b>
<b>17</b>	Clozitt <b>[FINO AD ESAURIMENTO SCORTE]</b>
<b>21</b>	Starfish Pro
<b>27</b>	<b>ORTESI</b>
<b>29</b>	HCO
<b>37</b>	Theratogs
<b>41</b>	<b>PASSEGGINI</b>
<b>43</b>	Yeti
<b>47</b>	Grizzly
<b>53</b>	Pegaz
<b>57</b>	<b>SEGGIOLONI</b>
<b>59</b>	Cumulix
<b>63</b>	Mouse
<b>67</b>	Mewa
<b>71</b>	Tigrotto <b>[FINE SERIE]</b>
<b>75</b>	<b>SISTEMI DI POSTURA</b>
<b>77</b>	Delfi Pro
<b>87</b>	Headaloft
<b>89</b>	Hop <b>[FINE SERIE]</b>
<b>93</b>	Sharky Pro
<b>99</b>	<b>SOLLEVATORI</b>
<b>101</b>	Body Up Evolution

---



# DEAMBULATORI



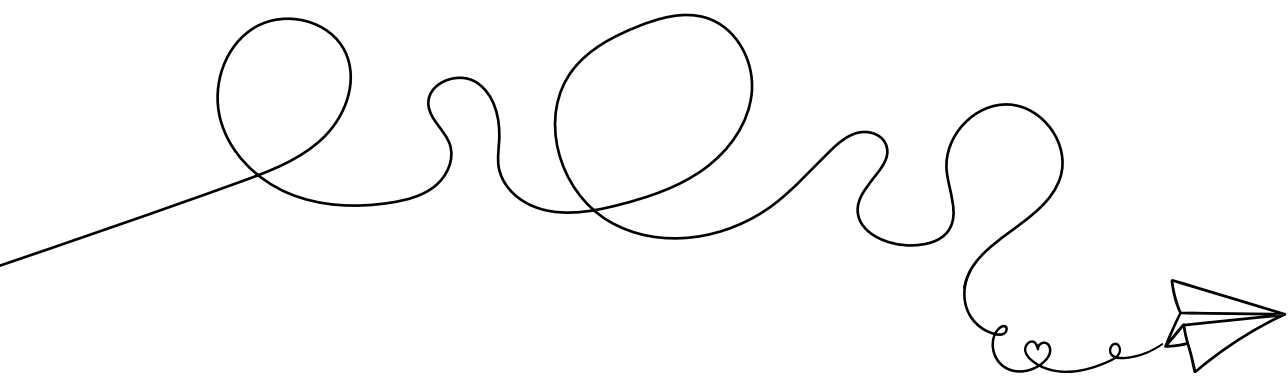



# BUDDY ROAMER

DEAMBULATORE

buddy  
roamer™

Fatturare a: \_\_\_\_\_

Ragionesociale: \_\_\_\_\_

Via: \_\_\_\_\_

Città: \_\_\_\_\_ C.A.P. \_\_\_\_\_

Provincia: \_\_\_\_\_

Tel. \_\_\_\_\_ Fax: \_\_\_\_\_

Spedire a: \_\_\_\_\_

\_\_\_\_\_

\_\_\_\_\_

Data ordine: \_\_\_\_\_

Num. Ordine: \_\_\_\_\_

Quantità richiesta: \_\_\_\_\_

## DESCRIZIONE

- Telaio;
- Supporti laterale regolabili;
- Poggiatesta telescopico standard;
- Pistone a molla regolabile;
- Freno di stazionamento;
- Blocco retro marcia;
- Ruote anti-ribaltamento;
- Paraurti ruote;
- Blocco direzione ruote.

Ordine     Preventivo

Inviare l'ordine via fax. **+39 0341 360931**

o via e-mail: [ordini@creha.it](mailto:ordini@creha.it).

Per info: Tel. **+39 0341 372350**.

## CODICE RDM

 739890

da **3.448,00 €**

## MISURE BUDDY ROAMER



MISURE	1	2	3	4
<b>DATI UTENTE</b>				
Peso Max	50 kg	50 kg	100 kg	100 kg
<b>DATI SEDUTA</b>				
Altezza sostegno capo	70÷130 cm	80÷140 cm	110÷200 cm	110÷200 cm
Larghezza torace	15÷23 cm	21÷36 cm	25÷40 cm	30÷50 cm
Larghezza bacino	15-23 cm	21+36 cm	25+40 cm	30+50 cm
Altezza terra-cavallo	20÷70 cm	30÷80 cm	40 ÷100 cm	40÷100 cm
Altezza da terra a cavo-ascellare	60÷100cm	70÷110cm	80÷120	-
Larghezza telaio	65 cm	65 cm	80 cm	-
Lunghezza telaio	80 cm	80 cm	93 cm	-
Peso ausilio	20 kg	20 kg	23 kg	23 kg
Inclinazione	-10°a +10°	-10°a +10°	-10°a +10°	-10°a +10°
Diametro ruota	20 cm	20 cm	20 cm	20 cm



## DOTAZIONE BASE & ACCESSORI

CODICE	NOME	MISURA	PREZZO	IVA	COD. DM	
<input type="checkbox"/> Roa 100	Buddy Roamer con dispositivo antiarretramento	1	3.448,00 €	4%		⇒ 
<input type="checkbox"/> Roa 200		2	3.448,00 €	4%		
<input type="checkbox"/> Roa 201		2+1	3.448,00 €	4%		
<input type="checkbox"/> Roa 300		3	3.998,00 €	4%		
<input type="checkbox"/> Roa 400		4	3.998,00 €	4%		
<b>ELEMENTI INCL. VERSIONE STANDARD - OPZIONI DI SCELTA INCL. VERSIONE STANDARD</b>						
<input type="checkbox"/> ROA012/A	Barra centrale di posizionamento (cilindro)	1 - 2	168,00 €	4%		
<input type="checkbox"/> ROA312		3 - 4	168,00 €	4%		
<input type="checkbox"/> ROA012R	Barra centrale di posizionamento con cuneo abduzione (sella)	1 - 2	168,00 €	4%		
<input type="checkbox"/> ROA312R		3 - 4	168,00 €	4%		
<b>ACCESSORI</b>						
<input type="checkbox"/> ROA007/LR	Poggiatesta large		299,00 €	4%		⇒ 
<input type="checkbox"/> ROA008/LR	Stabilizzatori di spalla swing away		499,00 €	4%		⇒ 
<input type="checkbox"/> ROA009R	Supporti arto superiore (antibrachiale)	1 - 2	698,00 €	4%		⇒ 
<input type="checkbox"/> ROA309R		3 - 4	698,00 €	4%		

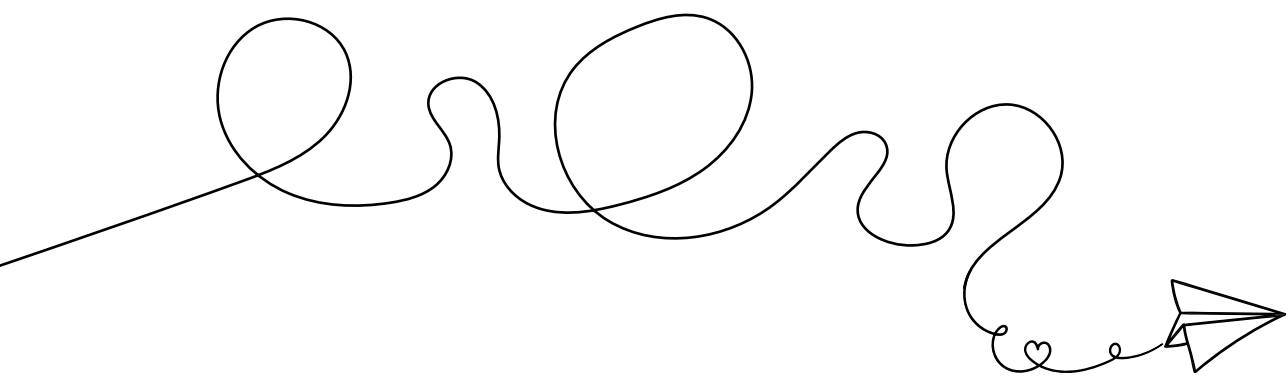



# VIAGGIO

DEAMBULATORE

**[FINE SERIE]**  
ultimi pezzi disponibili

Fatturare a: \_\_\_\_\_

Ragionesociale: \_\_\_\_\_

Via: \_\_\_\_\_

Città: \_\_\_\_\_ C.A.P. \_\_\_\_\_

Provincia: \_\_\_\_\_

Tel. \_\_\_\_\_ Fax: \_\_\_\_\_

Spedire a: \_\_\_\_\_

\_\_\_\_\_

\_\_\_\_\_

Data ordine: \_\_\_\_\_

Num. Ordine: \_\_\_\_\_

Quantità richiesta: \_\_\_\_\_

## DESCRIZIONE

- Regolazione altezza;
- Regolazione inclinazione;
- Blocco direzionale posteriore;
- Ruote piroettanti;
- Sella;
- Contenimento tronco modellabile;
- Contenimento bacino regolabile;
- Freni anteriori e posteriori;
- Manubrio;
- Regolatore resistenza ruota.

Ordine     Preventivo

Inviare l'ordine via fax. **+39 0341 360931**

o via e-mail: [ordini@creha.it](mailto:ordini@creha.it).

Per info: Tel. **+39 0341 372350**.

## CODICE RDM

 mis.1: 1665892

 mis.2: 1665927

 mis.3: 1665931

# 1.697,00 €

## MISURE VIAGGIO

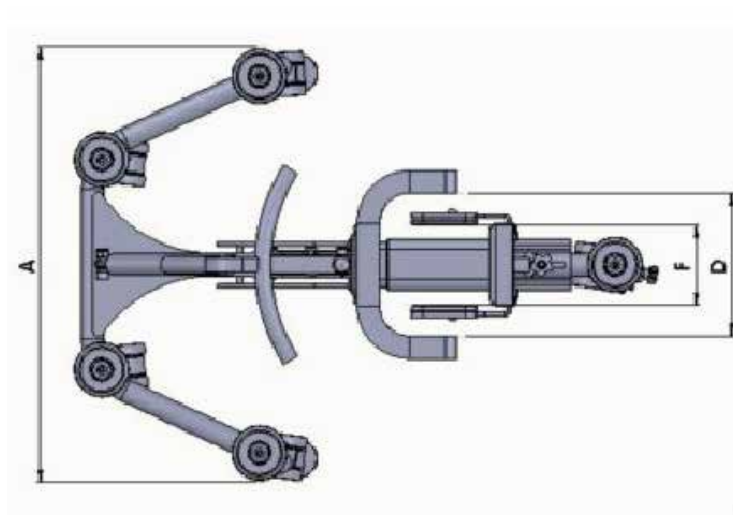
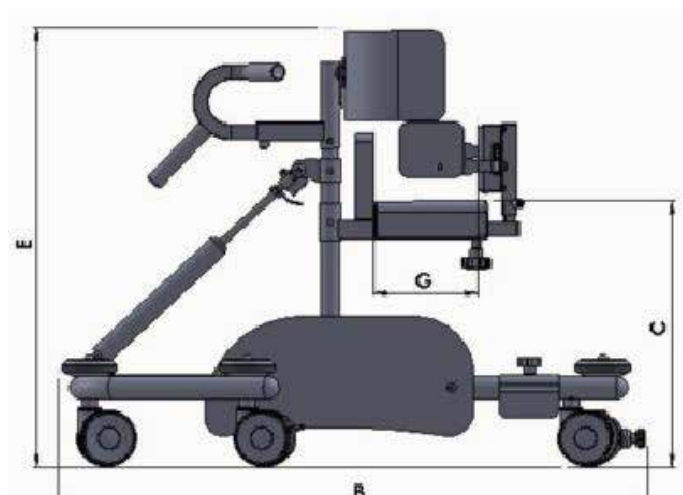

RIFERIMENTO	MISURE	1	2	3
<b>DATI UTENTE</b>				
	Peso (kg)	50 kg	60 kg	60 kg
<b>DATI SEDUTA</b>				
A	Larghezza totale	57,5 cm	67,5 cm	78 cm
B	Lunghezza totale	79 cm	79 cm	110 cm
C	Altezza sella	25÷39cm	38,5÷49 cm	47,5÷63,5 cm
D	Larghezza interna contenimento tronco	18,5 cm	24,5 cm	24,5 cm
E	Altezza terra sostegno tronco	53÷67 cm	62,5÷87 cm	73÷100 cm
F	Larghezza interna sostegni laterali	7÷24 cm	10÷27 cm	10÷27 cm
G	Profondità spinta sacrale	12÷24 cm	14,5÷26,5 cm	17÷26 cm
	Inclinazione struttura	31°	31°	31°



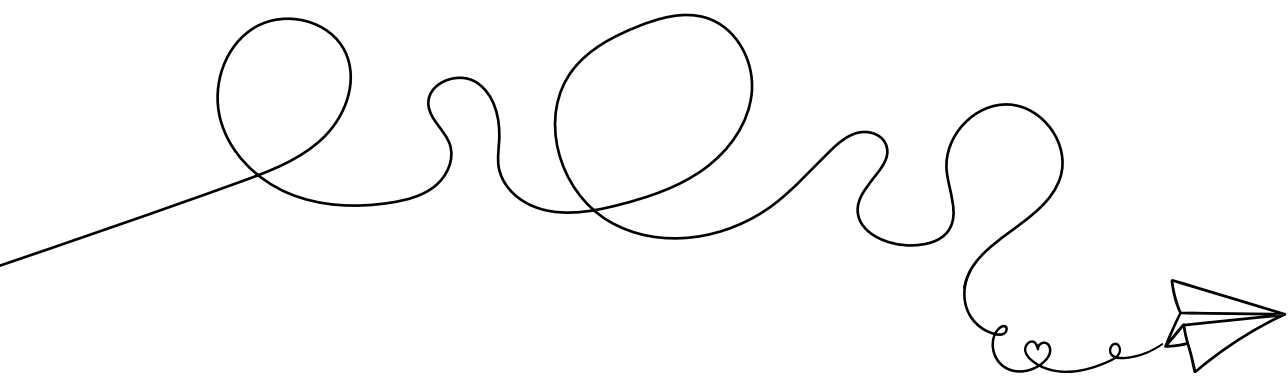

# IGIENE PERSONALE

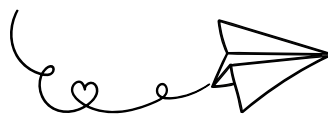

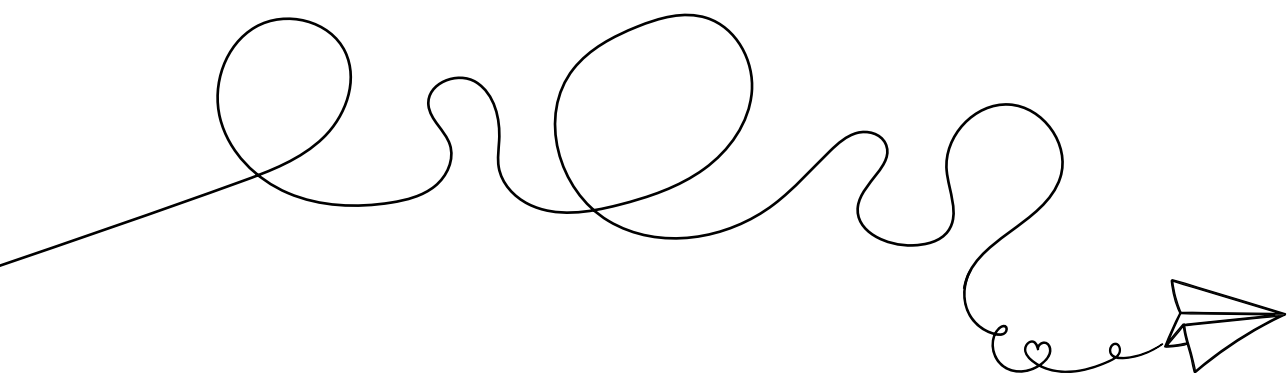





**[ FINO AD  
ESAURIMENTO  
SCORTE ]**

**CLOZITT**  
LINEA BAGNO



Fatturare a: \_\_\_\_\_

Ragionesociale: \_\_\_\_\_

Via: \_\_\_\_\_

Città: \_\_\_\_\_ C.A.P. \_\_\_\_\_

Provincia: \_\_\_\_\_

Tel. \_\_\_\_\_ Fax: \_\_\_\_\_

Spedire a: \_\_\_\_\_

\_\_\_\_\_

\_\_\_\_\_

Data ordine: \_\_\_\_\_

Num. Ordine: \_\_\_\_\_

Quantità richiesta: \_\_\_\_\_

## DESCRIZIONE

- Seduta fissa
- Sistema basculamento
- Contenimento tronco
- Prolunga schienale
- Pedana unica
- Divaricatore;
- Braccioli regolabili;
- Poggiatesta;
- Pettorine;
- Cintura pelvica.

Ordine     Preventivo

Inviare l'ordine via fax. **+39 0341 360931**

o via e-mail: **ordini@creha.it**.

Per info: Tel. **+39 0341 372350**.

## CODICE RDM

 37734

**2.648,00 €**

# MISURE CLOZITT

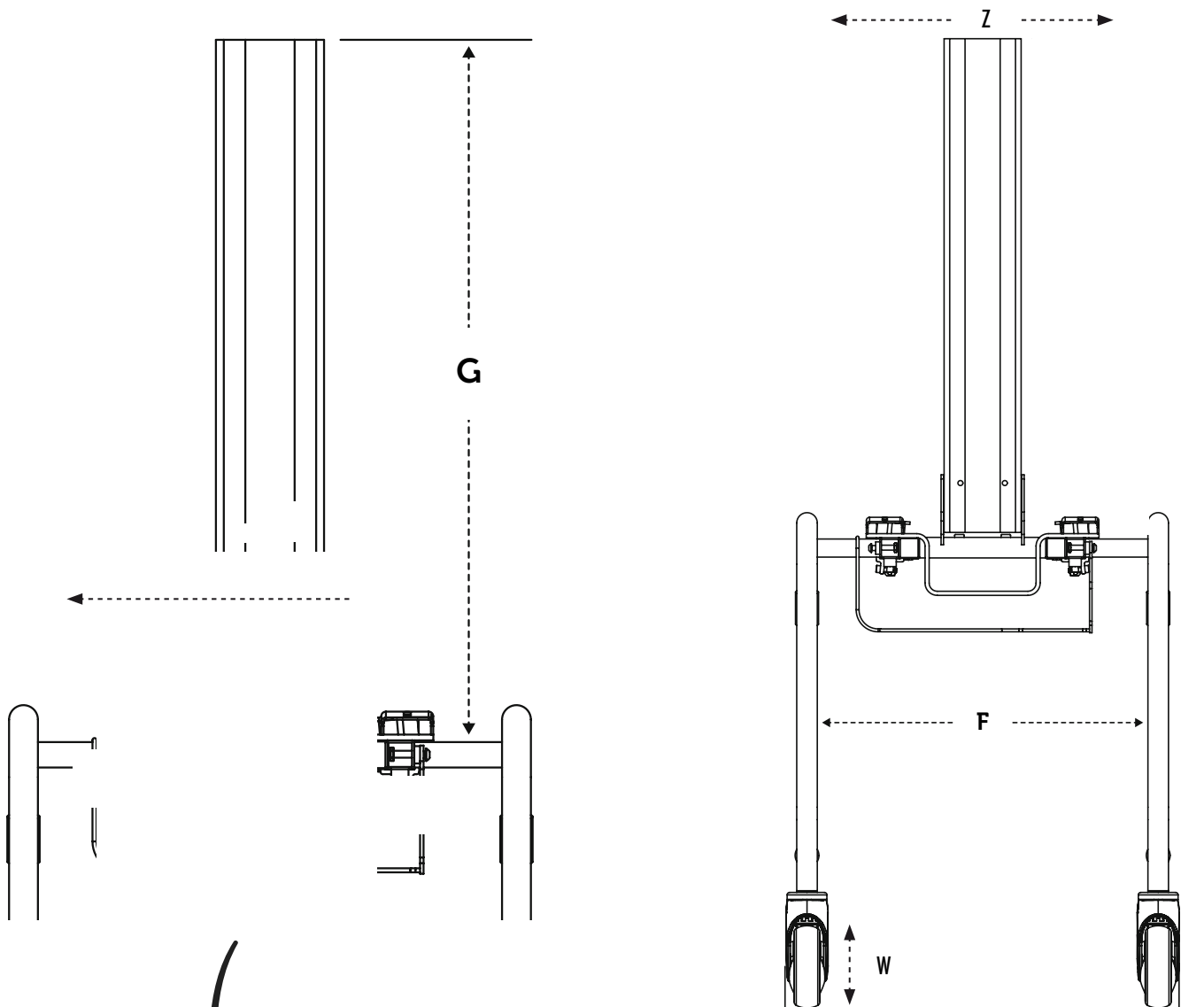

RIFERIMENTI	MISURE	1	2	3	4
<b>DATI UTENTE</b>					
	Peso max	130 kg			
<b>DATI SEDUTA</b>					
F	Larghezza seduta	26,5 cm	31,5 cm	36,5 cm	41,5 cm
D	Profondità seduta	26,5 cm	31,5 cm	36,5 cm	41,5 cm
Z	Larghezza schienale	22 cm	26 cm	29 cm	33 cm
	Basculamento	Pistone a gas 0° / +30°			
W	Ruote	100 mm			
<b>INGOMBRO TELAIO</b>					
	Larghezza	45 cm	45 cm	50 cm	50 cm
	Larghezza schienale	70 cm	70 cm	70 cm	70 cm

## DOTAZIONE BASE & ACCESSORI

CODICE	NOME	MISURA	PREZZO	IVA	COD. DM	
<input type="checkbox"/> 681121	CLOZITT	1	2.648,00 €	4%		
<input type="checkbox"/> 682221		2	2.648,00 €	4%		
<input type="checkbox"/> 683321		3	2.648,00 €	4%		
<input type="checkbox"/> 684421		4	2.648,00 €	4%		
<input type="checkbox"/> 689284	PM ATTACCO PETTORINA	-	-	4%		
<input type="checkbox"/> 376521	Pettorina	S	-	4%		
<input type="checkbox"/> 376531		M	-	4%		
<input type="checkbox"/> 376541		L	-	4%		
<b>ACCESSORI</b>						
<input type="checkbox"/> 374232	Cinghia antirotazione bacino	S	198,00 €	4%		
<input type="checkbox"/> 374241		M	198,00 €	4%		
<input type="checkbox"/> 670181	Protezione per urina	UNICA	108,00 €	4%		
<input type="checkbox"/> 689009	Vaschetta (opzionale per comoda)	1-2	108,00 €	4%		
<input type="checkbox"/> 689010		3-4	108,00 €	4%		
<b>CINTURINI</b>						
<input type="checkbox"/> 378111	Cinturino Soft polso	L	88,00 €	4%		
<input type="checkbox"/> 378211		S	88,00 €	4%		
<input type="checkbox"/> 377111	Cinturino Caviglia	S	88,00 €	4%		
<input type="checkbox"/> 377211		M	88,00 €	4%		
<input type="checkbox"/> 377311		L	88,00 €	4%		
<b>TAVOLINO</b>						
<input type="checkbox"/> 26402/1	Tavolino	1-2	298,00 €	4%		
<input type="checkbox"/> 26403		3	298,00 €	4%		
<input type="checkbox"/> 26404		4	298,00 €	4%		

CODICE	NOME	MISURA	PREZZO	IVA	COD. DM	
<b>POGGIATESTA</b>						
<input type="checkbox"/> 689065	Poggiatesta lungo *	1-2	58,00 € *	4%		⇒ 
<input type="checkbox"/> 689067		3-4	58,00 € *	4%		
<b>PEDANA</b>						
<input type="checkbox"/> 689025	Pedana separata *	1-2	108,00 € *	4%		⇒ 
<input type="checkbox"/> 689727		3-4	108,00 € *	4%		
<input type="checkbox"/> 689029	Imbottitura pedana unica *	1-2	108,00 € *	4%		⇒ 
<input type="checkbox"/> 689031		3-4	108,00 € *	4%		
<input type="checkbox"/> 689037	Appoggia polpaccio	1-2	208,00 € *	4%		⇒ 
<input type="checkbox"/> 689086		3-4	208,00 € *	4%		

\* Prezzo in aggiunta alla dotazione base. Per l'acquisto singolo richiedere un preventivo.

## NOTE

---

---

---

---

---

---

---

---

---

---

---

---

---

---

---



# STARFISH PRO

LINEA BAGNO



Fatturare a: \_\_\_\_\_

Ragionesociale: \_\_\_\_\_

Via: \_\_\_\_\_

Città: \_\_\_\_\_ C.A.P. \_\_\_\_\_

Provincia: \_\_\_\_\_

Tel. \_\_\_\_\_ Fax: \_\_\_\_\_

Spedire a: \_\_\_\_\_

\_\_\_\_\_

\_\_\_\_\_

Data ordine: \_\_\_\_\_

Num. Ordine: \_\_\_\_\_

Quantità richiesta: \_\_\_\_\_

## DESCRIZIONE

- Braccioli regolabili in altezza e lunghezza;
- Poggiatesta lungo;
- Schienale regolabile in altezza ed inclinazione;
- Pedana separata regolabile in altezza;
- Base basculante;
- Supporti toracali regolabili in altezza, larghezza e inclinazione.

Ordine     Preventivo

Inviare l'ordine via fax. +39 0341 360931

o via e-mail: [ordini@creha.it](mailto:ordini@creha.it).

Per info: Tel. +39 0341 372350.

## CODICE RDM

➔ 1724828

# 4.619,00 €

# MISURE STARFISH PRO

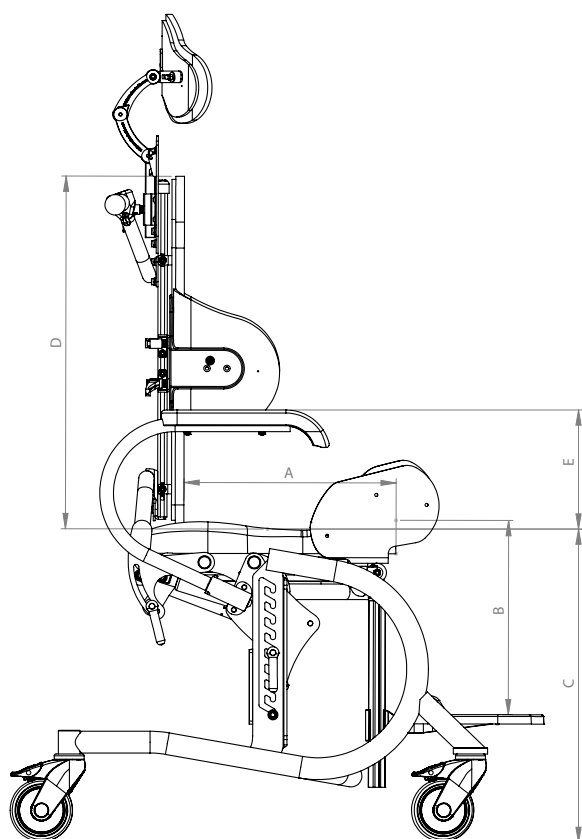

RIFERIMENTI	MISURE	1	2	3
<b>DATI UTENTE</b>				
	Peso	120 kg	120 kg	150 kg
	Altezza	120÷145 cm	140÷175 cm	170÷200 cm
<b>DATI SEDUTA</b>				
	Larghezza seduta	38 cm	45 cm	51 cm
<b>A</b>	Profondità seduta	30÷38 cm	36÷47 cm	45÷55 cm
	Contenimento laterale ginocchio	16,5 cm	18,5 cm	20 cm
<b>C</b>	Altezza seduta da terra regolata manualmente	53÷63 cm		

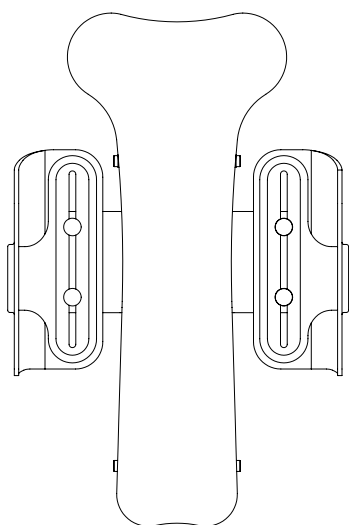
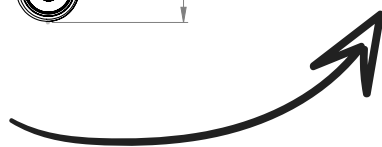

MISURE	1	2	3
<b>DATI SCHIENALE</b>			
Altezza telaio schienale	46 cm	56 cm	66 cm
Distanza min-max supporti toracali	21-30cm	24-34cm	30-40cm
Reclinazione schienale	10° + 35°		

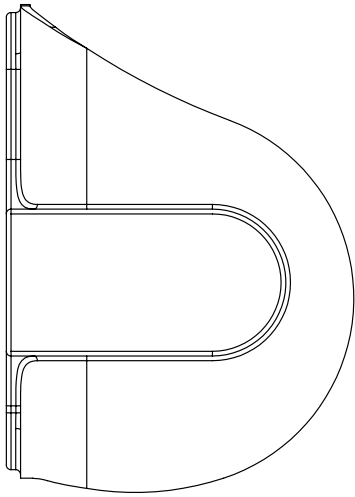

MISURE	1	2	3
<b>DATI SUPPORTI TORACALI</b>			
Profondità supporti toracali	14 cm	17 cm	20 cm
Altezza supporti toracali	21 cm	23 cm	26 cm

Pedana unica

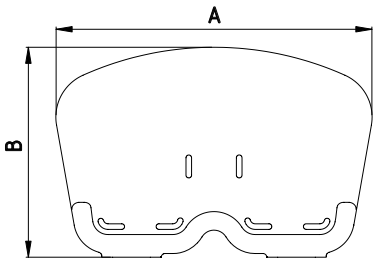

RIFERIMENTI	MISURE	1	2	3
<b>DATI PEDANA</b>				
A	Larghezza pedana unica	34,5 cm	38 cm	38 cm
B	Altezza pdana unica	22,5 cm	25,5 cm	31 cm
A	Larghezza pedana separata	16 cm	18 cm	18 cm
B	Altezza pedana separata	22 cm	25,5 cm	30,5 cm

Pedana separata

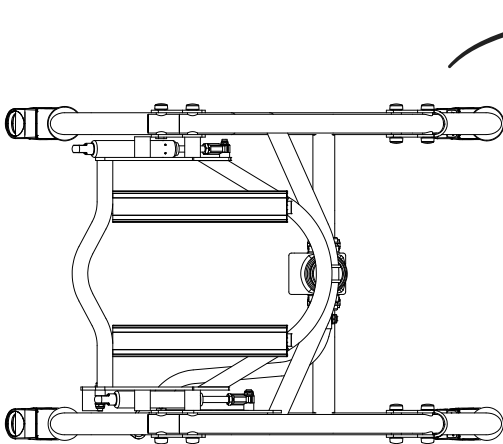
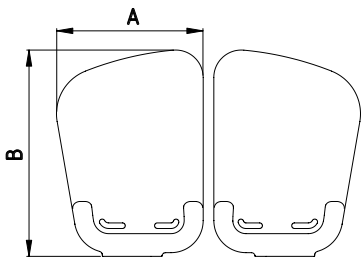

MISURE	1	2	3
<b>DATI UTENTE</b>			
Peso	120 kg	120 kg	150 kg
Altezza	120-145 cm	140-175 cm	170-200 cm
<b>DATI BASE</b>			
Larghezza base	54 cm	54 cm	59 cm
Lunghezza base	69 cm	69 cm	79 cm
Diametro ruote	10 cm	10 cm	10 cm
Peso totale	31 kg	33 kg	35 kg
Portata massima	120 kg	120 kg	150 kg
Basculamento	-5° +30°	-5° +30°	-5° +30°

## DOTAZIONE BASE & ACCESSORI

CODICE	NOME	MISURA	PREZZO	IVA	COD. DM	
<input type="checkbox"/> 689401	Starfish pro seduta intera su base da interno	1	4.619,00 €	4%		
<input type="checkbox"/> 689402		2	4.619,00 €	4%		
<input type="checkbox"/> 689403		3	4.619,00 €	4%		
<input type="checkbox"/> 689406	Starfish pro seduta divisa su base da interno	1	4.619,00 €	4%		
<input type="checkbox"/> 689407		2	4.619,00 €	4%		
<input type="checkbox"/> 689408		3	4.619,00 €	4%		
<input type="checkbox"/> 6894 71 - 76	Contenimento laterale gambe	1	-	4%		
<input type="checkbox"/> 6894 72 - 77		2	-	4%		
<input type="checkbox"/> 6894 73 - 78		3	-	4%		
<input type="checkbox"/> 689431	Schienale Starfish	1	-	4%		
<input type="checkbox"/> 689432		2	-	4%		
<input type="checkbox"/> 689433		3	-	4%		
<input type="checkbox"/> 689441	Supporto tronco	1	-	4%		
<input type="checkbox"/> 689442		2	-	4%		
<input type="checkbox"/> 689443		3	-	4%		
<input type="checkbox"/> 689461	Bracciolo (paio)	1	-	4%		
<input type="checkbox"/> 689462		2	-	4%		
<input type="checkbox"/> 689463		3	-	4%		
<input type="checkbox"/> 689456	Poggiatesta lungo	1	-	4%		
<input type="checkbox"/> 689458		2	-	4%		
<input type="checkbox"/> 689501	Pedana Divisa	1	-	4%		
<input type="checkbox"/> 689502		2	-	4%		
<input type="checkbox"/> 689503		3	-	4%		
ACCESSORI						
<input type="checkbox"/> 375211	Pettorina Pro	S	119,00 €	4%		
<input type="checkbox"/> 375311		M	119,00 €	4%		



CODICE	NOME	MISURA	PREZZO	IVA	COD. DM	
<b>ACCESSORI</b>						
<input type="checkbox"/> 375411	Pettorina Pro	L	119,00 €	4%		⇒ 
<input type="checkbox"/> 376521	Pettorina H	S	119,00 €	4%		⇒ 
<input type="checkbox"/> 376531		M	119,00 €	4%		
<input type="checkbox"/> 376541		L	119,00 €	4%		
<input type="checkbox"/> 374201	Cinghia pelvica	1				⇒ 
<input type="checkbox"/> 374211		2				
<input type="checkbox"/> 374221		3				
<input type="checkbox"/> 374232	Cinghia antirotazione bacino *	S	219,00 € *	4%		⇒ 
<input type="checkbox"/> 374241		M	219,00 € *	4%		
<input type="checkbox"/> 689284	PM supporto per pettorina (da ordinare sempre con pettorina)	UNICA	-	4%		⇒ 
<input type="checkbox"/> 689516	Imbottitura pedana divisa	1	149,00 €	4%		⇒ 
<input type="checkbox"/> 689517		2	149,00 €	4%		
<input type="checkbox"/> 689518		3	149,00 €	4%		
<input type="checkbox"/> 990252	Tavolino	2	298,00 €	4%		⇒ 
<input type="checkbox"/> 990253		3	298,00 €	4%		
<input type="checkbox"/> 990254		4	298,00 €	4%		
<input type="checkbox"/> 378111	Cinturino Soft polso	L	109,00 €	4%		⇒ 
<input type="checkbox"/> 378211		S	109,00 €	4%		
<input type="checkbox"/> 377111	Cinturino Caviglia	S	109,00 €	4%		⇒ 
<input type="checkbox"/> 377211		M	109,00 €	4%		
<input type="checkbox"/> 377311		L	109,00 €	4%		

CODICE	NOME	MISURA	PREZZO	IVA		
ACCESSORI						
<input type="checkbox"/> 689533	Protezione Urina	M	149,00 €	4%		➔ 
<input type="checkbox"/> 689534	Protezione Urina	L	149,00 €	4%		
<input type="checkbox"/> 689526	Vaschetta urina	1-2	149,00 €	4%		➔ 
<input type="checkbox"/> 689527		3	149,00 €	4%		

\* Prezzo in aggiunta alla dotazione base. Per l'acquisto singolo richiedere un preventivo.

## NOTE

---

---

---

---

---

---

---

---

---

---

---

---

# ORTESI



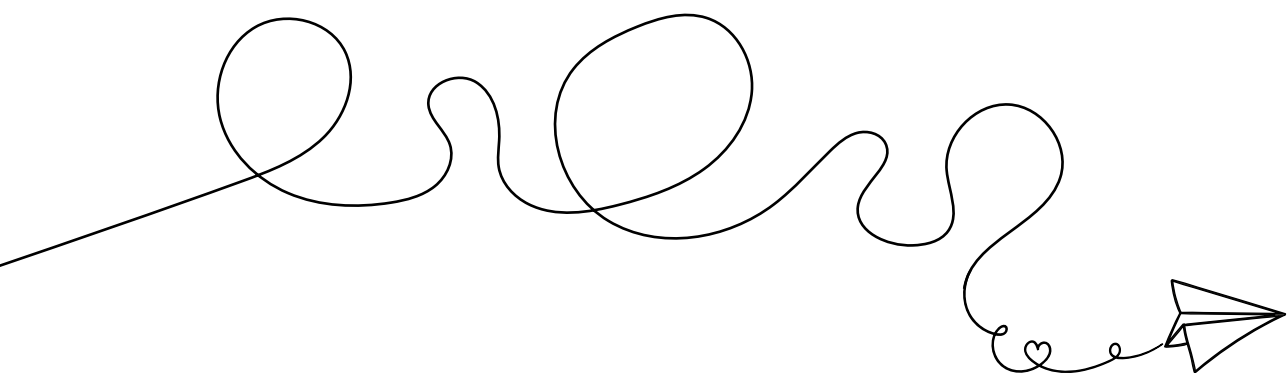



# HCO

HYLTON COMPRESSION ORTHOSIS  
ORTESI

*Hylton*  
COMPRESSION ORTHOTICS

Fatturare a: \_\_\_\_\_

Ragionesociale: \_\_\_\_\_

Via: \_\_\_\_\_

Città: \_\_\_\_\_ C.A.P. \_\_\_\_\_

Provincia: \_\_\_\_\_

Tel. \_\_\_\_\_ Fax: \_\_\_\_\_

Spedire a: \_\_\_\_\_

\_\_\_\_\_

\_\_\_\_\_

Data ordine: \_\_\_\_\_

Num. Ordine: \_\_\_\_\_

Quantità richiesta: \_\_\_\_\_

## DESCRIZIONE

Le ortesi Hylton Compression Orthosis (HCO) sono state sviluppate per bambini con disturbi neurologici di svariata eziologia.

Le ortesi Hylton lavorano sul concetto della compressione flessibile e aiutano la riduzione dell'ipotono; migliorano la sensibilità corporea, l'equilibrio, la stabilità dinamica, il controllo del movimento e le lunghezze muscolari.

Ordine     Preventivo

Inviare l'ordine via fax. **+39 0341 360931**

o via e-mail: [ordini@creha.it](mailto:ordini@creha.it).

Per info: Tel. **+39 0341 372350**.

## CODICE RDM

### KIT BODY

➡ 1786592

### KIT TRONCO

➡ 1786667

### KIT ARTO INFERIORE

➡ 1786647

### KIT GUANTO

➡ 1786650

### KIT PRESA GOMITO

➡ 1786649

# MISURE KIT ORTESI



**KIT BODY**

Codice	MISURE
VS 44	Circonferenza torace: 44 cm, 30.75 cm lungh.
VS 47	Circonferenza torace: 47 cm, 34.5 cm lungh.
VS 51	Circonferenza torace: 51 cm, 38.25 cm lungh.
VS 54	Circonferenza torace: 54 cm, 44 cm lungh.
VS 57	Circonferenza torace: 57 cm, 47.75 cm lungh.
VS 60	Circonferenza torace: 60 cm, 51.5 cm lungh.
VS 64	Circonferenza torace: 64 cm, 55.25 cm lungh.
VS 67	Circonferenza torace: 67 cm, 59 cm lungh.



**KIT TRONCO**

Cod. lunga	Cod. corta	MISURE
S41	SS 41	Circonferenza torace: 41 cm, 23.00 cm lungh.
S44	SS 44	Circonferenza torace: 44 cm, 27.94 cm lungh.
S47	SS 47	Circonferenza torace: 47 cm, 31.11 cm lungh.
S51	SS 51	Circonferenza torace: 51 cm, 35.56 cm lungh.
S54	SS 54	Circonferenza torace: 54 cm, 39.00 cm lungh.
S57	SS 57	Circonferenza torace: 57 cm, 45.72 cm lungh.
S60	SS 60	Circonferenza torace: 60 cm, 47.00 cm lungh.
S64	SS 64	Circonferenza torace: 64 cm, 50.50 cm lungh.
S67	SS 67	Circonferenza torace: 67 cm, 56.40 cm lungh.



**KIT ARTI INFERIORI**

Cod. lungo	Cod. corto	MISURE
P 43	SP 43	Girovita: 43 cm, SP 27.30 cm lungh. / P 40.33 cm lungh.
P 45	SP 45	Girovita: 45 cm, SP 30.48 cm lungh. / P 45.00 cm lungh.
P 47	SP 47	Girovita: 47 cm, SP 32.00 cm lungh. / P 47.95 cm lungh.
P 49	SP 49	Girovita: 49 cm, SP 33.02 cm / P 49.80 cm lungh.
P 51	SP 51	Girovita: 51 cm, SP 34.29 cm / P 52.70 cm lungh.
P 53	SP 53	Girovita: 53 cm, SP 36.83 cm / P 56.84 cm lungh.
P 55	SP 55	Girovita: 55 cm, SP 39.37 cm / P 63.19 cm lungh.
P 57	SP 57	Girovita: 57 cm, SP 42.54 cm / P 66.60 cm lungh.
P 59	SP 59	Girovita: 59 cm, SP 45.30 cm lungh. / P 70.04 cm lungh.
P 61	SP 61	Girovita: 61 cm, SP 46.00 cm lungh. / P 71.70 cm lungh.
P 63	SP 63	Girovita: 63 cm, SP 48.89 cm lungh. / P 77.80 cm lungh.
P 65	SP 65	Girovita: 65 cm, SP 50.16 cm lungh. / P 79.30 cm lungh.
P 67	SP 67	Girovita: 67 cm, SP 54.70 cm lungh. / P 81.70 cm lungh.
P 69	SP 69	Girovita: 69 cm, SP 55.25 cm lungh. / P 83.20 cm lungh.

## KIT PRESA GOMITO

Codice	MISURE
AS13	Circonferenza del braccio: 13 cm, 19.05 cm lungh.
AS14	Circonferenza del braccio: 14 cm, 20.06 cm lungh.
AS16	Circonferenza del braccio: 16 cm, 22.86 cm lungh.
AS17	Circonferenza del braccio: 17 cm, 24.07 cm lungh.
AS18	Circonferenza del braccio: 18 cm, 28.00 cm lungh.
AS20	Circonferenza del braccio: 20 cm, 30.48 cm lungh.
AS21	Circonferenza del braccio: 21 cm, 32.04 cm lungh.
AS22	Circonferenza del braccio: 22 cm, 35.56 cm lungh.
AS24	Circonferenza del braccio: 24 cm, 38.10 cm lungh.



## KIT GUANTO



Codice	MISURE
G5	Largh. del palmo: 5 cm, 11.43 cm lungh.
G5.5	Largh. del palmo: 5.5 cm, 12.19 cm lungh.
G6	Largh. del palmo: 6 cm, 13.03 cm lungh.
G6.5	Largh. del palmo: 6.5 cm, 14.04 cm lungh.
G7	Largh. del palmo: 7 cm, 15.55 cm lungh.
G7.5	Largh. del palmo: 7.5 cm, 16.50 cm lungh.
G8	Largh. del palmo: 8 cm, 17.02 cm lungh.



## DOTAZIONE BASE & ACCESSORI

CODICE		NOME	MISURA	PREZZO	IVA	
KIT BODY						
<input type="checkbox"/>	VS 44	KIT BODY	1	818,00 €	4%	
<input type="checkbox"/>	VS 47		2	818,00 €	4%	
<input type="checkbox"/>	VS 51		3	818,00 €	4%	
<input type="checkbox"/>	VS 54		4	818,00 €	4%	
<input type="checkbox"/>	VS 57		5	818,00 €	4%	
<input type="checkbox"/>	VS 60		6	818,00 €	4%	
<input type="checkbox"/>	VS 64		7	818,00 €	4%	
<input type="checkbox"/>	VS 67		8	818,00 €	4%	
<b>MANICA LUNGA</b>	<b>MANICA CORTA</b>	KIT TRONCO				
<input type="checkbox"/>	S 41	KIT TRONCO	1	572,00 €	4%	
<input type="checkbox"/>	S 44 <input type="checkbox"/> SS 44		2	572,00 €	4%	
<input type="checkbox"/>	S 47 <input type="checkbox"/> SS 47		3	572,00 €	4%	
<input type="checkbox"/>	S 51 <input type="checkbox"/> SS 51		4	572,00 €	4%	
<input type="checkbox"/>	S 54 <input type="checkbox"/> SS 54		5	572,00 €	4%	
<input type="checkbox"/>	S 57 <input type="checkbox"/> SS 57		6	572,00 €	4%	
<input type="checkbox"/>	S 60 <input type="checkbox"/> SS 60		7	572,00 €	4%	
<input type="checkbox"/>	S 64 <input type="checkbox"/> SS 64		8	572,00 €	4%	
<input type="checkbox"/>	S 67 <input type="checkbox"/> SS 67		9	572,00 €	4%	
ACCESSORI SOLO PER BODY						
<input type="checkbox"/>	X 44	PANNELLO RIGIDO X	1	190,00 €	4%	
<input type="checkbox"/>	X 47		2	190,00 €	4%	
<input type="checkbox"/>	X 51		3	190,00 €	4%	
<input type="checkbox"/>	X 54		4	190,00 €	4%	
<input type="checkbox"/>	X 57		5	190,00 €	4%	
<input type="checkbox"/>	X 60		6	190,00 €	4%	
<input type="checkbox"/>	X 64		7	190,00 €	4%	
<input type="checkbox"/>	X 67		8	190,00 €	4%	



CODICE		NOME	MISURA	PREZZO	IVA	
LUNGO	CORTO	KIT ARTI INFERIORI				
<input type="checkbox"/> P 43	<input type="checkbox"/> SP 43	KIT ARTO INFERIORE	1	678,00 €	4%	
<input type="checkbox"/> P 45	<input type="checkbox"/> SP 45		2	678,00 €	4%	
<input type="checkbox"/> P 47	<input type="checkbox"/> SP 47		3	678,00 €	4%	
<input type="checkbox"/> P 49	<input type="checkbox"/> SP 49		4	678,00 €	4%	
<input type="checkbox"/> P 51	<input type="checkbox"/> SP 51		5	678,00 €	4%	
<input type="checkbox"/> P 53	<input type="checkbox"/> SP 53		6	678,00 €	4%	
<input type="checkbox"/> P 55	<input type="checkbox"/> SP 55		7	678,00 €	4%	
<input type="checkbox"/> P 57	<input type="checkbox"/> SP 57		8	678,00 €	4%	
<input type="checkbox"/> P 59	<input type="checkbox"/> SP 59		9	678,00 €	4%	
<input type="checkbox"/> P 61	<input type="checkbox"/> SP 61		10	678,00 €	4%	
<input type="checkbox"/> P 63	<input type="checkbox"/> SP 63		11	678,00 €	4%	
<input type="checkbox"/> P 65	<input type="checkbox"/> SP 65		12	678,00 €	4%	
<input type="checkbox"/> P 67	<input type="checkbox"/> SP 67		13	678,00 €	4%	
<input type="checkbox"/> P 69	<input type="checkbox"/> SP 69		14	678,00 €	4%	
KIT GUANTO						
<input type="checkbox"/> G 5		KIT GUANTO	1	194,89 €	4%	
<input type="checkbox"/> G 5.5			2	194,89 €	4%	
<input type="checkbox"/> G 6			3	194,89 €	4%	
<input type="checkbox"/> G 6.5			4	194,89 €	4%	
<input type="checkbox"/> G 7			5	194,89 €	4%	
<input type="checkbox"/> G 7.5			6	194,89 €	4%	
<input type="checkbox"/> G 8			7	194,89 €	4%	
KIT PRESA GOMITO						
<input type="checkbox"/> AS 13		KIT PRESA GOMITO	1	98,00 €	4%	
<input type="checkbox"/> AS 14			2	98,00 €	4%	
<input type="checkbox"/> AS 16			3	98,00 €	4%	
<input type="checkbox"/> AS 17			4	98,00 €	4%	
<input type="checkbox"/> AS 18			5	98,00 €	4%	
<input type="checkbox"/> AS 20			6	98,00 €	4%	
<input type="checkbox"/> AS 21			7	98,00 €	4%	
<input type="checkbox"/> AS 22			8	98,00 €	4%	
<input type="checkbox"/> AS 24			9	98,00 €	4%	

# COMPONI IL TUO KIT SU MISURA

		PREZZO	IVA		
<b>KIT BODY + PANTALONE</b>					
Inserisci il codice del body:	<input type="text"/>	1.055,55 €	4%	⇒	
Inserisci il codice del pantalone:	<input type="text"/>				+
<b>KIT MAGLIETTA + PANTALONE</b>					
Inserisci il codice della maglietta:	<input type="text"/>	809,54 €	4%	⇒	
Inserisci il codice del pantalone:	<input type="text"/>				+

## NOTE

---



---



---



---



---

# LINEA FABRIFLEX

## FABRIFLEX WRAPS

Codice	MISURE (HxL)
F720	18 cm x 50 cm
F930	23 cm x 76 cm
F1135	28 cm x 89 cm

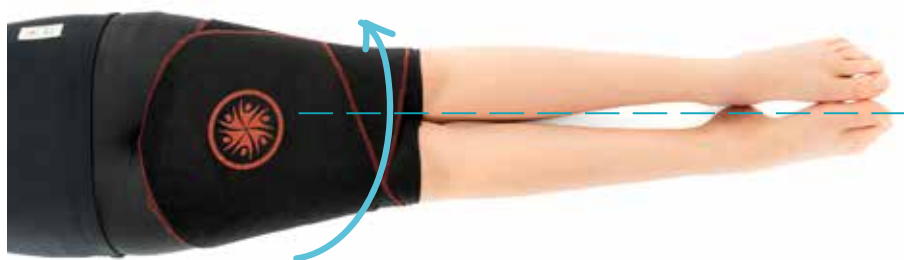

## FABRIFLEX STRAPS

Codice	MISURE
FP2	H 5 cm - 3 pezzi per confezione (lunghezza cm 76 - 101 - 127)
FP4	H 10 cm - 2 pezzi per confezione (lunghezza cm 76 - 127)







# THERATOGS

ORTESI



Fatturare a: \_\_\_\_\_

Ragionesociale: \_\_\_\_\_

Via: \_\_\_\_\_

Città: \_\_\_\_\_ C.A.P. \_\_\_\_\_

Provincia: \_\_\_\_\_

Tel. \_\_\_\_\_ Fax: \_\_\_\_\_

Spedire a: \_\_\_\_\_

\_\_\_\_\_

\_\_\_\_\_

Data ordine: \_\_\_\_\_

Num. Ordine: \_\_\_\_\_

Quantità richiesta: \_\_\_\_\_

## DESCRIZIONE

Il kit ortesico TheraTogs è stato pensato per favorire un miglioramento dell'assetto posturale, della capacità e della precisione del movimento e della stabilità articolare, soprattutto in quei soggetti che risultano affetti da patologie dello sviluppo, con lesioni cerebrali, o con specifici problemi muscolo-scheletrici, posturali, di equilibrio, o di movimento.

Ordine     Preventivo

Inviare l'ordine via fax. **+39 0341 360931**

o via e-mail: **ordini@creha.it**.

Per info: Tel. **+39 0341 372350**.

# MISURE THERATOGS



## LINEA PEDIATRICA

MODELLO	NOME	ETÀ	PESO	LUNG. TRONCO	CIRCONF. ADDOME
GWZ25	Wunzi XXS	0÷3 mesi	3÷5 Kg	40 cm	40 cm
GWZ50	Wunzi XS	3÷6 mesi	5÷8 Kg	50 cm	44 cm
GWZ75	Wunzi S	6÷12 mesi	8÷8,5 Kg	55 cm	46 cm
GWZLKS	Limb kit S	0÷12 mesi	oltre 8,5 Kg		
GWZ100	Wunzi M	12÷18 mesi	8,5÷9,5 Kg	60 cm	50 cm
GWZ125	Wunzi L	18÷24 mesi	9,5÷12 kg	68 cm	54 cm
GWZLKL	Limb kit L	12÷24 mesi	oltre 12 kg		





MISURE	PESO	MAX ATK	MAX STA	PTA	FULL BODY	KIT ARTI INFERIORI
Bambino	7÷11 kg	25 cm	27 cm	GPTA110	GFB100	GLE101
Età prescolare	11÷20 kg	30 cm	24 cm	GPTA210	GFB200	GLE201
Pediatrico	20÷30 kg	47 cm	38 cm	GPTA310	GFB300	GLE301
11-13 anni	30÷50 kg	53 cm	44 cm	GPTA410	GFB400	GLE401

Kit Polso Pollice - taglia 307 - misura adatta ad una fascia di età pediatrica (neonati, prescolare e scolare)  
 Kit Polso Pollice - taglia 317 - misura adatta ad una fascia di età adolescenziale e adulta

## LINEA ADULTO

MISURE	PESO	MAX ATK	MAX STA	KIT COMPLETO	KIT ARTI INFERIORI
11 - 13 anni	30÷50 kg	53 cm	44 cm	GFB400	GLE401
Donna S	50÷64 kg	60 cm	52 cm	GFB600	GLE601
Donna M	64÷77 kg	60 cm	52 cm	GFB610	GLE611
Donna L	77÷91 kg	67 cm	58 cm	GFB620	GLE621
Uomo S	50÷66 kg	60 cm	49 cm	GFB700	GLE701
Uomo M	66÷77 kg	60 cm	49 cm	GFB710	GLE711
Uomo L	77÷86 kg	67 cm	57 cm	GFB720	GLE721
Uomo XL	86÷109 kg	67 cm	59 cm	GFB730	GLE731

## DOTAZIONE BASE & ACCESSORI

CODICE	NOME	MISURA	PREZZO	IVA	COD. DM	
<b>KIT FULL BODY</b>						
<input type="checkbox"/> GFB 100	Kit full body	1	1.354 €	4%		
<input type="checkbox"/> GFB 200		2	1.354 €	4%		
<input type="checkbox"/> GFB 300		3	1.354 €	4%		
<input type="checkbox"/> GFB 400		4	1.354 €	4%		
<input type="checkbox"/> GFB 600		6	1.354 €	4%		
<input type="checkbox"/> GFB 700		7	1.354 €	4%		
<b>KIT ARTI INFERIORI</b>						
<input type="checkbox"/> GLE 101	Kit arti inferiori	1	1.096 €	4%		
<input type="checkbox"/> GLE 201		2	1.096 €	4%		
<input type="checkbox"/> GLE 301		3	1.096 €	4%		
<input type="checkbox"/> GLE 401		4	1.096 €	4%		
<input type="checkbox"/> GLE 601		6	1.096 €	4%		
<b>KIT POLSO POLLICE</b>						
<input type="checkbox"/> GWT 307 R	Kit polso pollice	1DX	194,89 €	4%		
<input type="checkbox"/> GWT 307 L		1SX	194,89 €	4%		
<input type="checkbox"/> GWT 317 R		2DX	194,89 €	4%		
<input type="checkbox"/> GWT 317 L		2SX	194,89 €	4%		
<b>KIT TRONCO PTA</b>						
<input type="checkbox"/> GPTA 110	Kit PTA	1	936,00 €	4%		
<input type="checkbox"/> GPTA 210		2	936,00 €	4%		
<input type="checkbox"/> GPTA 310		3	936,00 €	4%		
<input type="checkbox"/> GPTA 410		4	936,00 €	4%		
<b>KIT WUNZY</b>						
<input type="checkbox"/> GWZ 75	Kit Wunzy	1	550,00 €	4%		
<input type="checkbox"/> GWZ 100		2	550,00 €	4%		
<input type="checkbox"/> GWZ 125		3	550,00 €	4%		

# NOTE

---

---

---

---

---

---

---

---

---

---

---

---



# PASSEGGINI

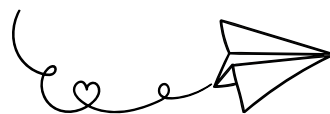

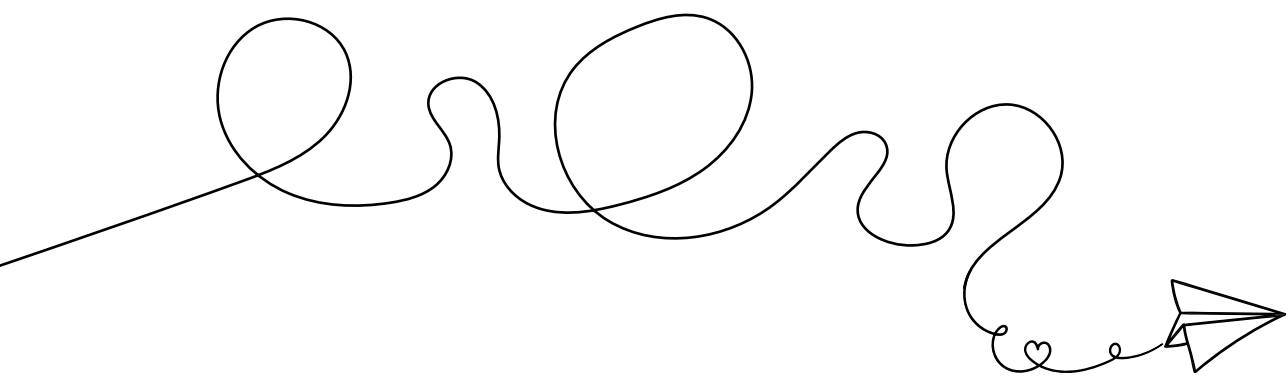



# YETI

PASSEGGINO POSTURALE



Fatturare a: \_\_\_\_\_  
Ragionesociale: \_\_\_\_\_  
Via: \_\_\_\_\_  
Città: \_\_\_\_\_ C.A.P. \_\_\_\_\_  
Provincia: \_\_\_\_\_  
Tel. \_\_\_\_\_ Fax: \_\_\_\_\_

Spedire a: \_\_\_\_\_  
\_\_\_\_\_  
\_\_\_\_\_  
Data ordine: \_\_\_\_\_  
Num. Ordine: \_\_\_\_\_  
Quantità richiesta: \_\_\_\_\_

## DESCRIZIONE

- Schienale reclinabile
- Poggiatesta regolabile in altezza e larghezza
- Contenimenti tronco regolabili in altezza e larghezza
- Contenimenti bacino
- Pedana regolabile in altezza e flesso-estensione
- Bretellaggio
- Seduta basculante
- Ruote piroettanti ed estraibili
- Freno di stazionamento
- Divaricatore

Ordine     Preventivo

Inviare l'ordine via fax. **+39 0341 360931**

o via e-mail: [ordini@creha.it](mailto:ordini@creha.it).

Per info: Tel. **+39 0341 372350**.

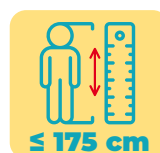

## CODICE RDM

➔ 2051033

# 2.696,00 €

## MISURE YETI



MISURE	UNICA
<b>DATI UTENTE</b>	
Peso (kg)	75 kg
Altezza (cm)	130÷175 cm
<b>DATI SEDUTA</b>	
Larghezza seduta	31÷43 cm
Profondità seduta	31÷45 cm
Altezza schienale	65÷85 cm
Larghezza massima schienale	30÷42 cm
Lunghezza pedana-seduta	29÷44cm
Reclinazione schienale	90°÷175°
<b>DATI AUSILIO</b>	
Larghezza	66 cm
Lunghezza	120 cm
Altezza	134cm
Peso	22 kg
Portata massima	80 kg
Diametro ruote anteriori	18,5 cm
Diametro ruote posteriori	28,5 cm
Angolo di basculamento	0°÷30°
Dimensioni chiuso (L-H-P)	111-43-66



## DOTAZIONE BASE & ACCESSORI

CODICE	NOME	MISURA	PREZZO	IVA	COD. DM
<input type="checkbox"/> YETI	YETI GRIGIO	UNICA	2.696,00 €	4%	
OPTIONAL - KIT MF "MAMMA FELICE"					
<input type="checkbox"/> YETI KIT MF	KIT MAMMA FELICE		369,00 €	4%	

### KIT MAMMA FELICE

- cappottina
- ombrellino
- borsa da viaggio
- tavolino
- guantini
- zanzariera
- parapioggia
- coprigambe



### NOTE

---

---

---

---

---

---

---

---

---

---

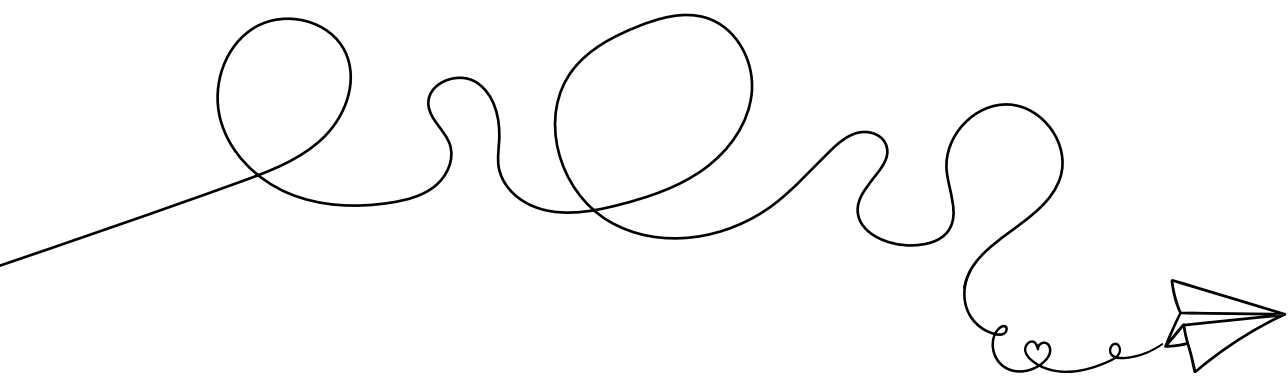



# GRIZZLY

PASSEGGINO



Fatturare a: \_\_\_\_\_

Ragione sociale: \_\_\_\_\_

Via: \_\_\_\_\_

Città: \_\_\_\_\_ C.A.P. \_\_\_\_\_

Provincia: \_\_\_\_\_

Tel. \_\_\_\_\_ Fax: \_\_\_\_\_

Spedire a: \_\_\_\_\_

\_\_\_\_\_

\_\_\_\_\_

Data ordine: \_\_\_\_\_

Num. Ordine: \_\_\_\_\_

Quantità richiesta: \_\_\_\_\_

## DESCRIZIONE

- Schienale reclinabile;
- Poggiatesta regolabile in altezza e larghezza;
- Contenimenti tronco regolabili in altezza e larghezza;
- Contenimenti cosce;
- Pedana regolabile in altezza e flesso-estensione;
- Bretellaggio;
- Seduta basculante;
- Ruote piroettanti ed estraibili;
- Freno di stazionamento;
- Divaricatore;
- Tavolino.

Ordine     Preventivo

Inviare l'ordine via fax. **+39 0341 360931**

o via e-mail: [ordini@creha.it](mailto:ordini@creha.it).

Per info: Tel. **+39 0341 372350**.

## CODICE RDM

➔ 1697627

# 2.819,00 €

## MISURE GRIZZLY







MISURE	UNICA
<b>DATI UTENTE</b>	
Peso (kg)	45 kg
Altezza (cm)	85÷140 cm
<b>DATI SEDUTA</b>	
Larghezza seduta	18÷40 cm
Profondità seduta	25÷37 cm
Altezza schienale	57÷70 cm
Distanza min-max supporti anca	18÷35cm
Distanza min-max supporto toracolombare	19÷34cm
Distanza min-max supporti schienale	15÷30cm
Larghezza massima schienale	34 cm
Larghezza poggiatesta	13 cm
Lunghezza pedana-seduta	23÷40,5cm
Larghezza pedana	20 cm
Reclinazione schienale	90°÷ 175°
<b>DATI AUSILIO</b>	
Larghezza	61 cm
Lunghezza	100cm
Altezza	121cm
Peso	17 kg
Portata massima	45 kg
Diametro ruote anteriori	18,5cm
Diametro ruote posteriori	28,5 cm
Angolo di basculamento	0°-30°
Dimensioni chiuso (L-H-P)	84-55-63





## DOTAZIONE BASE & ACCESSORI

CODICE	NOME	MISURA	PREZZO	IVA	COD. DM	
<input type="checkbox"/> GRIZZLY	<input type="checkbox"/> BORGOGNA	UNICA	2.819,00 €	4%		
	<input type="checkbox"/> GRIGIO	UNICA	2.819,00 €			
	<input type="checkbox"/> BLU	UNICA	2.819,00 €			
<input type="checkbox"/>	Schienale reclinabile		-	4%		
<input type="checkbox"/>	Poggiatesta regolabile in altezza e larghezza		-	4%		 
<input type="checkbox"/>	Contenimenti tronco regolabili in altezza e larghezza		-	4%		
<input type="checkbox"/>	Contenimenti cosce		-	4%		
<input type="checkbox"/>	Pedana regolabile in altezza e flessione		-	4%		 
<input type="checkbox"/>	Bretellaggio		-	4%		 
<input type="checkbox"/>	Seduta basculante		-	4%		
<input type="checkbox"/>	Ruote piroettanti ed estraibili		-	4%		
<input type="checkbox"/>	Freno di stazionamento		-	4%		
<b>OPTIONAL - KIT MF "MAMMA FELICE"</b>						
<input type="checkbox"/> GRIZZLY KIT MF	KIT MAMMA FELICE		369,00 €	4%		
<input type="checkbox"/>	Borsa viaggio		-	4%		 
<input type="checkbox"/>	Zanzariera		-	4%		 

CODICE	NOME	MISURA	PREZZO	IVA	COD. DM	
OPTIONAL - KIT MF "MAMMA FELICE"						
<input type="checkbox"/>	Parapioggia			- 4%		⇒ 
<input type="checkbox"/>	Cappottina apribile			- 4%		
<input type="checkbox"/>	Ombrellino			- 4%		⇒ 
<input type="checkbox"/>	Copri-gambe			- 4%		⇒ 
<input type="checkbox"/>	Guanti termici			- 4%		⇒ 

## NOTE

---



---



---



---



---



---



---



---



---



---

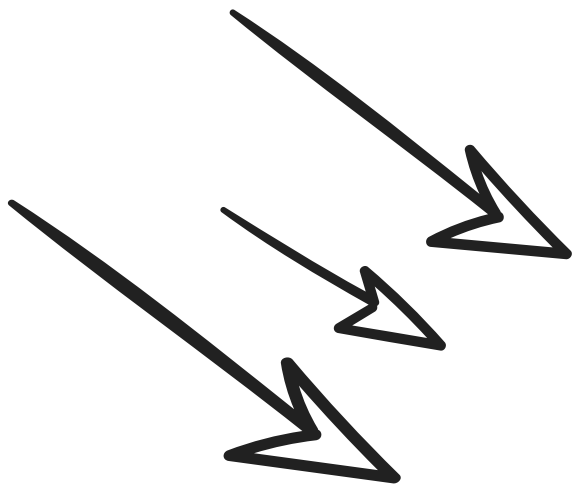

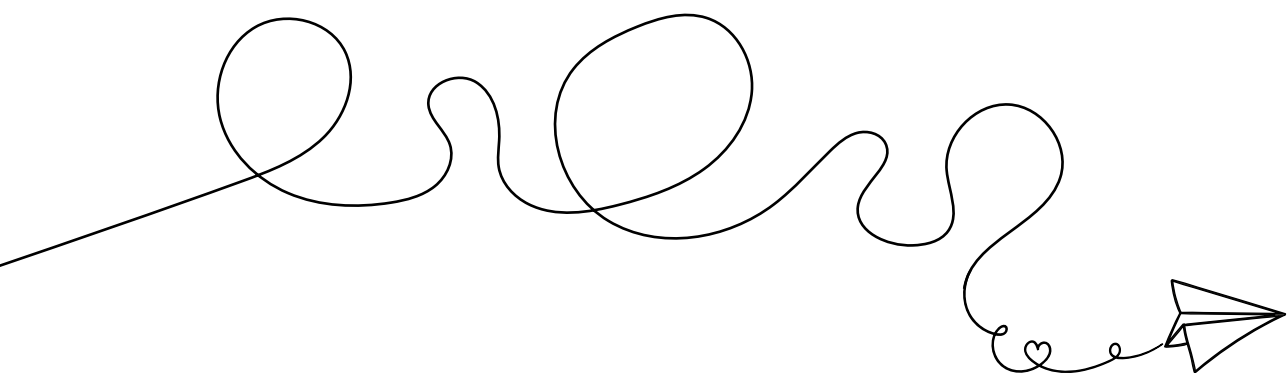



# PEGAZ

PASSEGGINO AD OMBRELLO



Fatturare a: \_\_\_\_\_

Ragionesociale: \_\_\_\_\_

Via: \_\_\_\_\_

Città: \_\_\_\_\_ C.A.P. \_\_\_\_\_

Provincia: \_\_\_\_\_

Tel. \_\_\_\_\_ Fax: \_\_\_\_\_

Spedire a: \_\_\_\_\_

\_\_\_\_\_

\_\_\_\_\_

Data ordine: \_\_\_\_\_

Num. Ordine: \_\_\_\_\_

Quantità richiesta: \_\_\_\_\_

## DESCRIZIONE

- Passeggino chiudibile ad ombrello;
- Cinghia bretellaggio;
- Poggiatesta regolabile;
- Barra di sicurezza;
- Divaricatore;
- Contenimento tronco;
- Pedana;
- Riduttori;
- Tavolino.

Ordine     Preventivo

Inviare l'ordine via fax. **+39 0341 360931**

o via e-mail: **ordini@creha.it**.

Per info: Tel. **+39 0341 372350**.

## CODICE RDM

➔ 1702324

# 1.369,00 €









## MISURE PEGAZ









MISURE	UNICA
<b>DATI UTENTE</b>	
Peso	35 kg
Altezza	125 cm
<b>DATI SEDUTA</b>	
Larghezza seduta	33 cm
Profondità seduta	30 cm
Altezza schienale	60 cm
Larghezza schienale	36 cm
Altezza pedana-seduta (min-max)	16+40 cm
<b>DATI AUSILIO</b>	
Larghezza	53 cm
Lunghezza	110 cm
Altezza	110 cm
Peso	10 kg
Portata massima	30 kg
Diametro ruote ant-post	18 cm



## DOTAZIONE BASE & ACCESSORI

CODICE	NOME	MISURA	PREZZO	IVA	COD. DM	
<input type="checkbox"/> PEGAZ	PEGAZ	UNICA	1.369,00 €	4%		
<input type="checkbox"/>	Passeggino chiudibile ad ombrello		-	4%		
<input type="checkbox"/>	Cinghia bretellaggio		-	4%		⇒ 
<input type="checkbox"/>	Poggiatesta regolabile		-	4%		⇒ 
<input type="checkbox"/>	Barra sicurezza		-	4%		⇒ 
<input type="checkbox"/>	Contenimenti tronco		-	4%		⇒ 
<input type="checkbox"/>	Divaricatore		-	4%		⇒ 
<input type="checkbox"/>	Pedana unica		-	4%		⇒ 
<input type="checkbox"/>	Riduttori capo e tronco		-	4%		⇒ 
<input type="checkbox"/>	Tavolino		-	4%		⇒ 
<b>OPTIONAL - KIT MF "MAMMA FELICE"</b>						
<input type="checkbox"/> PEGAZ KIT MF	KIT MAMMA FELICE		198,00 €	4%		

CODICE	NOME	MISURA	PREZZO	IVA	COD. DM	
<b>OPTIONAL - KIT MF "MAMMA FELICE"</b>						
<input type="checkbox"/>	Borsa viaggio			- 4%		⇒ 
<input type="checkbox"/>	Cappottina apribile			- 4%		⇒ 
<input type="checkbox"/>	Zanzariera			- 4%		
<input type="checkbox"/>	Parapioggia			- 4%		
<input type="checkbox"/>	Ombrellino			- 4%		⇒ 
<input type="checkbox"/>	Coprigambe			- 4%		⇒ 

## NOTE

---



---



---



---



---



---



---



# SEGGIOLONI



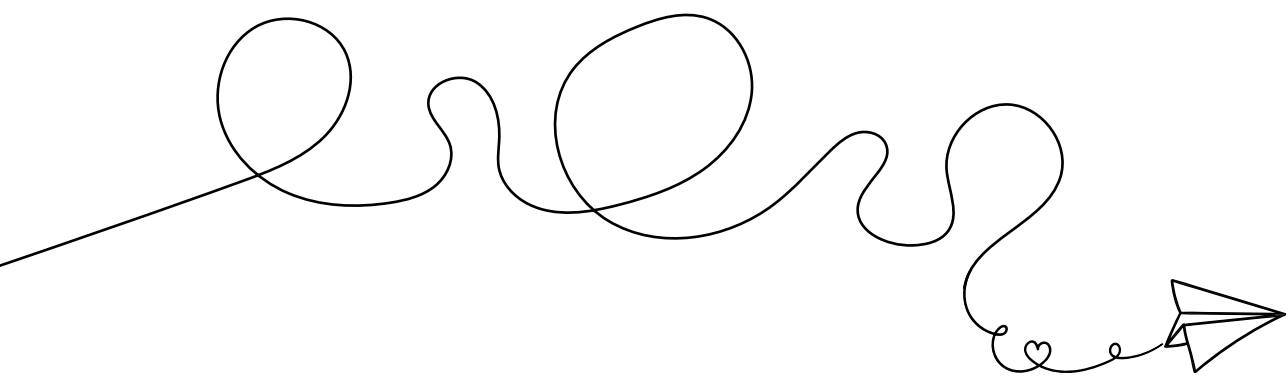



# CUMULIX

SEGGIOLONE



Fatturare a: \_\_\_\_\_

Ragionesociale: \_\_\_\_\_

Via: \_\_\_\_\_

Città: \_\_\_\_\_ C.A.P. \_\_\_\_\_

Provincia: \_\_\_\_\_

Tel. \_\_\_\_\_ Fax: \_\_\_\_\_

Spedire a: \_\_\_\_\_

\_\_\_\_\_

\_\_\_\_\_

Data ordine: \_\_\_\_\_

Num. Ordine: \_\_\_\_\_

Quantità richiesta: \_\_\_\_\_

## DESCRIZIONE

- Seggiolone polifunzionale con pedana, braccioli regolabili in altezza e poggiatesta.

Ordine     Preventivo

Inviare l'ordine via fax. +39 0341 360931

o via e-mail: [ordini@creha.it](mailto:ordini@creha.it).

Per info: Tel. +39 0341 372350.

## CODICE RDM

➔ 1729133

# 2.968,00 €

# MISURE CUMULIX



MISURE	S	M	L
<b>DATI SEDUTA</b>			
Larghezza seduta	34÷40	40÷46	46÷52
Profondità seduta		48cm	
Altezza seduta da terra		60 cm	
Altezza schienale		60 cm	
Inclinazione schienale		85°÷140°	
Altezza bracciolo		17÷26 cm	
Altezza pedana	45 cm	50 cm	50 cm
Inclinazione della pedana		0°÷270°	
Basculamento		10°÷40°	
Portata massima		125 kg	
Dimensioni tavolino		66x52cm	
Peso complessivo		38 kg	
Larghezza totale		70 cm	
Lunghezza totale		145 cm	

## DOTAZIONE BASE & ACCESSORI

CODICE	NOME	MISURA	PREZZO	IVA	COD. DM	
<input type="checkbox"/> CUMULIX	Cumulix	<input type="checkbox"/> S	2.968,00 €	4%		⇒ 
		<input type="checkbox"/> M	2.968,00 €	4%		
		<input type="checkbox"/> L	2.968,00 €	4%		
<b>ACCESSORI</b>						
<input type="checkbox"/> 80257	Cover blu	UNICA	260,00 €	4%		
<input type="checkbox"/> 97619	Tavolino	UNICA	320,00 €	4%		
<input type="checkbox"/> 80259	Bracciolo avvolgente dx	UNICA	268,00 €	4%		⇒ 
<input type="checkbox"/> 80258	Bracciolo avvolgente sx	UNICA	268,00 €	4%		
<input type="checkbox"/> 80945	Pedana swing	UNICA	490,00 €	4%		⇒ 
						⇒ 
<input type="checkbox"/>	Poggiatesta rigido standard		196,00 € *	4%		⇒ 
<input type="checkbox"/> 80294	Poggiatesta morbido		250,00 € *	4%		⇒ 
<input type="checkbox"/> 79963	Cover seduta per Cumulix con pedana swing		198,00 €			
<input type="checkbox"/> 80947	Cover pedana swing		108,00 €			
PIARE	Piatto respiratore		98,00 €	22%		⇒ 

\* Prezzo in aggiunta alla dotazione base. Per l'acquisto singolo richiedere un preventivo.

# NOTE

---

---

---

---

---

---

---

---

---

---

---

---

---





# MOUSE

SEGGIOLONE



Fatturare a: \_\_\_\_\_

Ragionesociale: \_\_\_\_\_

Via: \_\_\_\_\_

Città: \_\_\_\_\_ C.A.P. \_\_\_\_\_

Provincia: \_\_\_\_\_

Tel. \_\_\_\_\_ Fax: \_\_\_\_\_

Spedire a: \_\_\_\_\_

\_\_\_\_\_

\_\_\_\_\_

Data ordine: \_\_\_\_\_

Num. Ordine: \_\_\_\_\_

Quantità richiesta: \_\_\_\_\_

## DESCRIZIONE

- Ruote estraibili
- Schienale reclinabile
- Poggiatesta regolabile
- Divaricatore
- Pedana pieghevole e regolabile
- Cintura a 5 punti
- Kit accessori

Ordine     Preventivo

Inviare l'ordine via fax. +39 02 3910311

o via e-mail: [ordini@creha.it](mailto:ordini@creha.it).

Per info: Tel. +39 02 39100410.

## CODICE RDM

➡ 2051039



Grigio



**Misura Unica**

# 1.886,00 €

## MISURE MOUSE



MISURE	UNICA
<b>DATI UTENTE</b>	
Peso	30 kg
Altezza	80-110 cm
<b>DATI SEDUTA</b>	
Larghezza seduta	24-30 cm
Profondità seduta	22-26 cm
Altezza schienale	52 cm
Larghezza massima torace	25 cm
Lunghezza pedana-seduta	14÷23 cm
Reclinazione schienale	90°-170°
<b>DATI AUSILIO</b>	
Larghezza	60 cm
Lunghezza	113 cm
Altezza	134 cm
Peso	17 kg
Portata massima	30 kg
Diametro ruote anteriori	24 cm
Diametro ruote posteriori	30 cm
Dimensioni chiuso (L-H-P)	84-58-25 cm



## DOTAZIONE BASE & KIT ACCESSORI

CODICE	NOME	MISURA	PREZZO	IVA	COD. DM
<input type="checkbox"/> MOUSE	MOUSE GRIGIO	UNICA	1.886,00 €	4%	

### KIT ACCESSORI



Para-pioggia



Zanzariera



Copri-gambe



Cappotta



Tavolino



Ombrello

### OPTIONAL - KIT MF "MAMMA FELICE"

<input type="checkbox"/> MOUSE KIT MF	KIT MAMMA FELICE		208,00 €	4%	
---------------------------------------	------------------	--	----------	----	--

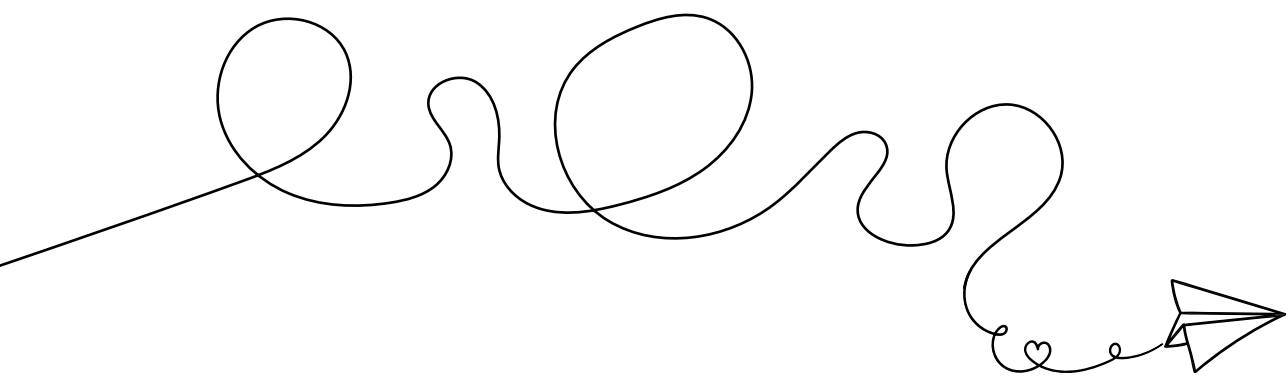



# MEWA

SEGGIOLONE



Fatturare a: \_\_\_\_\_

Ragionesociale: \_\_\_\_\_

Via: \_\_\_\_\_

Città: \_\_\_\_\_ C.A.P. \_\_\_\_\_

Provincia: \_\_\_\_\_

Tel. \_\_\_\_\_ Fax: \_\_\_\_\_

Spedire a: \_\_\_\_\_

\_\_\_\_\_

\_\_\_\_\_

Data ordine: \_\_\_\_\_

Num. Ordine: \_\_\_\_\_

Quantità richiesta: \_\_\_\_\_

## DESCRIZIONE

- Ruote estraibili
- Seggiolone richiudibile;
- Cinghia bretellaggio;
- Poggiatesta regolabile;
- Divaricatore;
- Pedana;
- Tavolino;
- Contenimento tronco.

Ordine     Preventivo

Inviare l'ordine via fax. **+39 0341 360931**

o via e-mail: **ordini@creha.it**.

Per info: Tel. **+39 0341 372350**.

## CODICE RDM

➔ 1330237

# 1.689,00 €







## MISURE MEWA



MISURE	UNICA
<b>DATI UTENTE</b>	
Peso	35 kg
Altezza	125 cm
<b>DATI SEDUTA</b>	
Larghezza seduta	32 cm
Profondità seduta	26 cm
Altezza schienale	60 cm
Larghezza massima torace	25 cm
Lunghezza pedana-seduta	19÷31 cm
Reclinazione schienale	90°-170°
<b>DATI AUSILIO</b>	
Larghezza	65,5 cm
Lunghezza	118 cm
Altezza	124 cm
Peso	20 kg
Portata massima	35 kg
Diametro ruote anteriori	24 cm
Diametro ruote posteriori	30 cm
Dimensioni chiuso con ruote (L-H-P)	65-39-105 cm
Dimensioni chiuso senza ruote (L-H-P)	64-24-87 cm

## DOTAZIONE BASE & ACCESSORI

CODICE	NOME	MISURA	PREZZO	IVA	COD. DM	
	<input type="checkbox"/> ROSA	UNICA	1.689,00 €	4%		⇒ 
<input type="checkbox"/> MEWA	<input type="checkbox"/> VERDE	UNICA	1.689,00 €	4%		⇒ 
	<input type="checkbox"/> AZZURRO	UNICA	1.689,00 €	4%		⇒ 
<input type="checkbox"/>	Ruote estraibili		-	4%		
<input type="checkbox"/>	Seggiolone richiudibile		-	4%		
<input type="checkbox"/>	Cinghia bretellaggio		-	4%		⇒ 
<input type="checkbox"/>	Poggiatesta regolabile		-	4%		⇒ 
<input type="checkbox"/>	Divaricatore		-	4%		⇒ 
<input type="checkbox"/>	Pedana unica		-	4%		⇒ 
<input type="checkbox"/>	Tavolino		-	4%		⇒ 
<input type="checkbox"/>	Contenimento tronco		-	4%		

CODICE	NOME	MISURA	PREZZO	IVA	COD. DM	
<b>OPTIONAL - KIT MF "MAMMA FELICE"</b>						
<input type="checkbox"/> MEWA KIT MF	KIT MAMMA FELICE		228,00 €	4%		
<input type="checkbox"/>	Borsa viaggio		-	4%		⇒ 
<input type="checkbox"/>	Zanzariera		-	4%		⇒ 
<input type="checkbox"/>	Parapioggia		-	4%		⇒ 
<input type="checkbox"/>	Guanti termici (paio)		-	4%		⇒ 
<input type="checkbox"/>	Cappottina apribile		-	4%		⇒ 
<input type="checkbox"/>	Ombrello parasole		-	4%		⇒ 
<input type="checkbox"/>	Copri-gambe		-	4%		⇒ 

## NOTE

---



---



---



---



---



---



# TIGROTTO

SEGGIOLONE POLIFUNZIONALE

**[FINE SERIE]**  
ultimi pezzi disponibili

Fatturare a: \_\_\_\_\_

Ragionesociale: \_\_\_\_\_

Via: \_\_\_\_\_

Città: \_\_\_\_\_ C.A.P. \_\_\_\_\_

Provincia: \_\_\_\_\_

Tel. \_\_\_\_\_ Fax: \_\_\_\_\_

Spedire a: \_\_\_\_\_

\_\_\_\_\_

\_\_\_\_\_

Data ordine: \_\_\_\_\_

Num. Ordine: \_\_\_\_\_

Quantità richiesta: \_\_\_\_\_

## DESCRIZIONE

- Seduta
- Schienale
- Base da interno + piastra
- Braccioli
- Poggiatesta
- Pedana unica
- Cintura 4 punti

Ordine     Preventivo

Inviare l'ordine via fax. **+39 0341 360931**

o via e-mail: [ordini@creha.it](mailto:ordini@creha.it).

Per info: Tel. **+39 0341 372350**.

## CODICE RDM

 1991527

# 1.780,00 €

# MISURE TIGROTTO

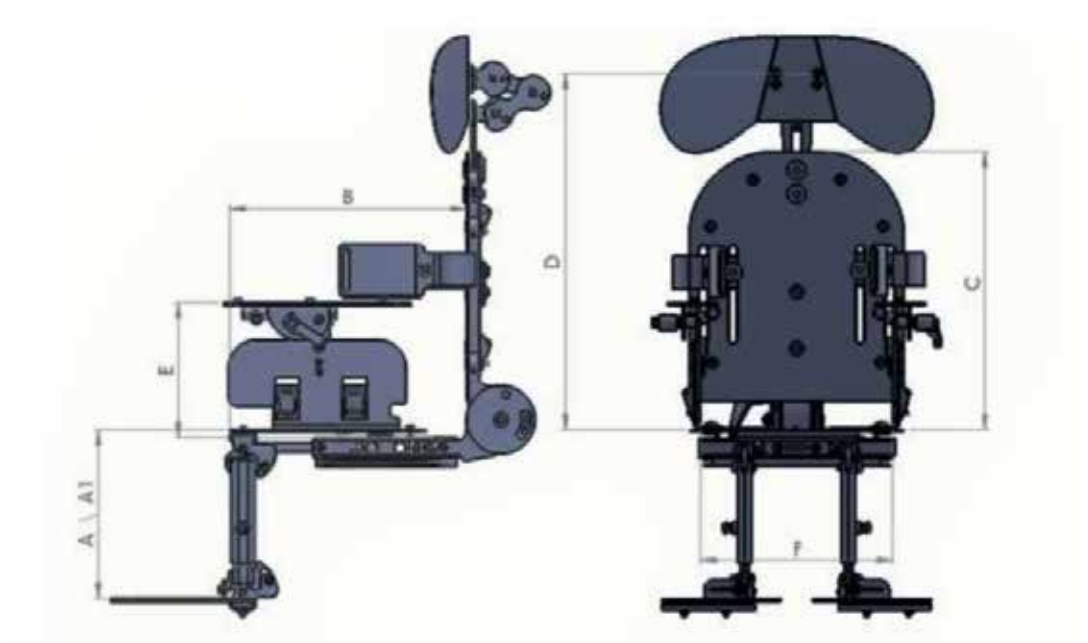

RIFERIMENTI	MISURE	0	1	2
F	Larghezza seduta	17 - 25 cm	25 - 33 cm	25 - 33 cm
B	Profondità seduta	20 - 25,5 cm	24 - 32 cm	32 - 40 cm
C	Altezza schienale	28 - 36 cm	28 - 36 cm	38 - 47,5 cm
	Inclinazione schienale	35°	35°	35°
D	Altezza poggiatesta	32 - 44 cm		
E	Altezza bracciolo	12 - 16,5 cm		12 - 16,5 cm
A	Altezza pedana doppia	20 - 26 cm		24 - 33 cm
A1	Altezza pedana unica	19 - 27 cm		22,5 - 34 cm



## DOTAZIONE BASE & ACCESSORI

CODICE	NOME	MISURA	PREZZO	IVA	COD. DM	
<input type="checkbox"/>	Colore: Rosa/Taupe					
<input type="checkbox"/>	Colore: Sky/Taupe					
<input type="checkbox"/>	VN 1200-0 + ASV 5	0	1.780,00 €	4%		⇒ 
<input type="checkbox"/>	VN 1200-1 + ASV5	1	1.780,00 €	4%		
<input type="checkbox"/>	VN 1200-2 + ASV5	2	1.780,00 €	4%		
<input type="checkbox"/>	VN 9003	0-1	-	4%		⇒ 
<input type="checkbox"/>	VN 9003 - 1	2	-	4%		
<input type="checkbox"/>	ASV-16	UNICA	-	4%		⇒ 
<input type="checkbox"/>	ASV-115	0	-	4%		
<input type="checkbox"/>	ASV-82	1	-	4%		
<input type="checkbox"/>	ASV-104	2	-	4%		
<b>ACCESSORI</b>						
<input type="checkbox"/>	ASV-123	0	70,00 € *	4%		⇒ 
<input type="checkbox"/>	ASV-10	1	70,00 € *	4%		
<input type="checkbox"/>	ASV-100	2	70,00 € *	4%		
<input type="checkbox"/>	ASV -30 -1	0-1	139,00 €	4%		⇒ 
<input type="checkbox"/>	ASV-91	2	139,00 €	4%		
<input type="checkbox"/>	C4P-0	0	45,00 €	4%		⇒ 
<input type="checkbox"/>	C4P-1/2	1-2	45,00 €	4%		
<input type="checkbox"/>	ASV 117	0	51,00 €	4%		⇒ 
<input type="checkbox"/>	ASV 116	1-2	51,00 €	4%		
<input type="checkbox"/>	ASV-119	0	79,00 €	4%		
<input type="checkbox"/>	ASV-103	1	79,00 €	4%		
<input type="checkbox"/>	ASV-108	2	79,00 €	4%		

CODICE	NOME	MISURA	PREZZO	IVA	COD. DM	
<input type="checkbox"/> ASV 128 L	Tavolo laminato	0	175,00 €	4%		
<input type="checkbox"/> ASV 129 L		1-2	175,00 €	4%		
<input type="checkbox"/> CB-0-T	Bretellaggio	0	79,00 €	4%		
<input type="checkbox"/> CB-1-T		1	79,00 €	4%		
<input type="checkbox"/> CB-2-T		2	79,00 €	4%		

\* Prezzo in aggiunta alla dotazione base. Per l'acquisto singolo richiedere un preventivo.

## NOTE

---

---

---

---

---

---

---

---

---

---

---

---

---

---

---

---

---

---

---

---

---

---

---

---

# SISTEMI DI POSTURA

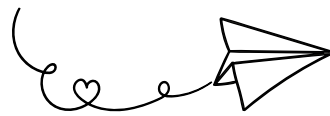

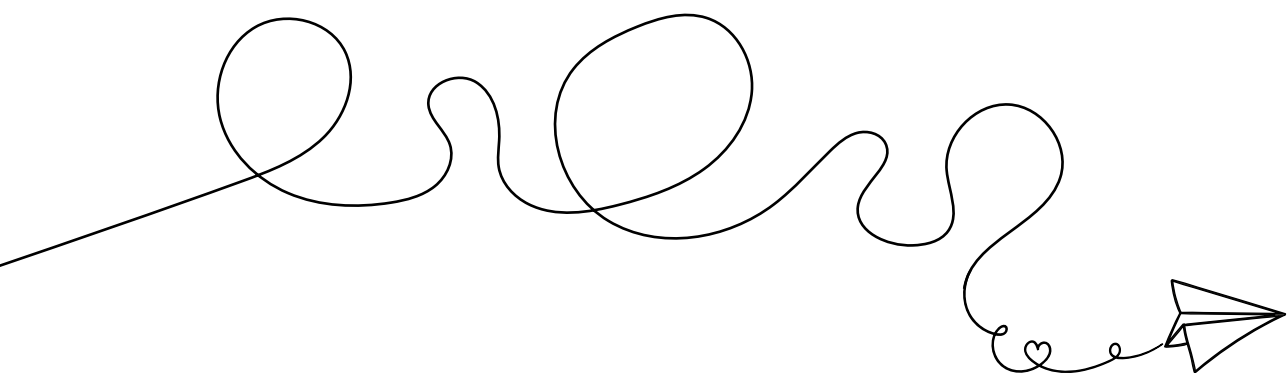



Fatturare a: \_\_\_\_\_

Ragionesociale: \_\_\_\_\_

Via: \_\_\_\_\_

Città: \_\_\_\_\_ C.A.P. \_\_\_\_\_

Provincia: \_\_\_\_\_

Tel. \_\_\_\_\_ Fax: \_\_\_\_\_

Spedire a: \_\_\_\_\_

\_\_\_\_\_

\_\_\_\_\_

Data ordine: \_\_\_\_\_

Num. Ordine: \_\_\_\_\_

Quantità richiesta: \_\_\_\_\_

## DESCRIZIONE

- Seduta con regolazione asimmetrica profondità
- Seduta con abductore regolabile lateralmente
- Cintura pelvica 4 punti
- Pedana unica
- Braccioli regolabili in altezza, inclinazione, profondità ed intra-extra rotazione
- Schienale flessibile per distonie
- Schienale regolabile in altezza ed inclinazione

Ordine     Preventivo

Inviare l'ordine via fax. **+39 0341 360931**

o via e-mail: [ordini@creha.it](mailto:ordini@creha.it).

Per info: Tel. **+39 0341 372350**.

## CODICE RDM

➡ mis.0: 2236365

➡ mis.1: 229845

➡ mis.2: 229848

➡ mis.3: 229849

➡ mis.4: 2236492

da **2.880,00 €**

# MISURE DELFI

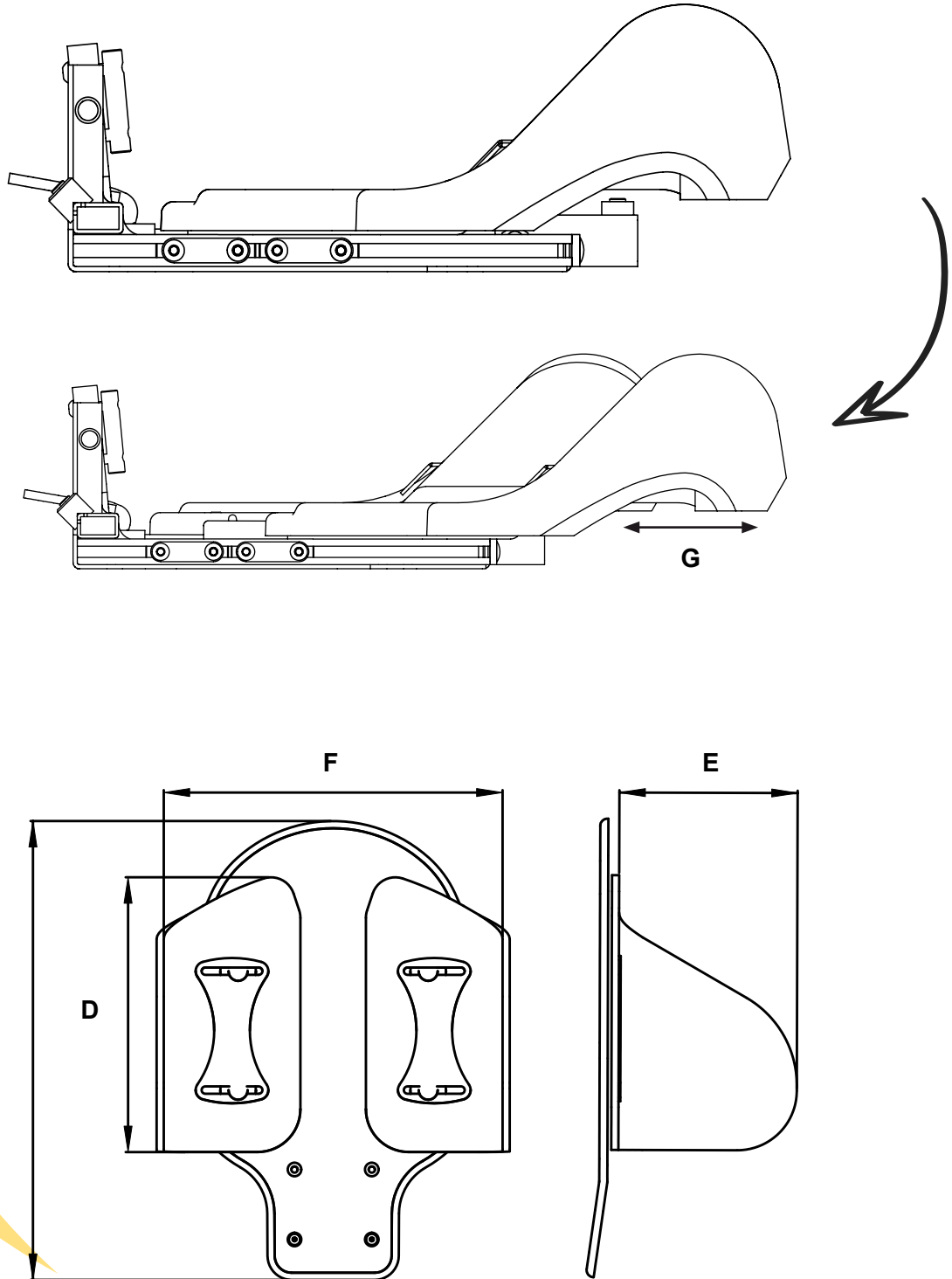

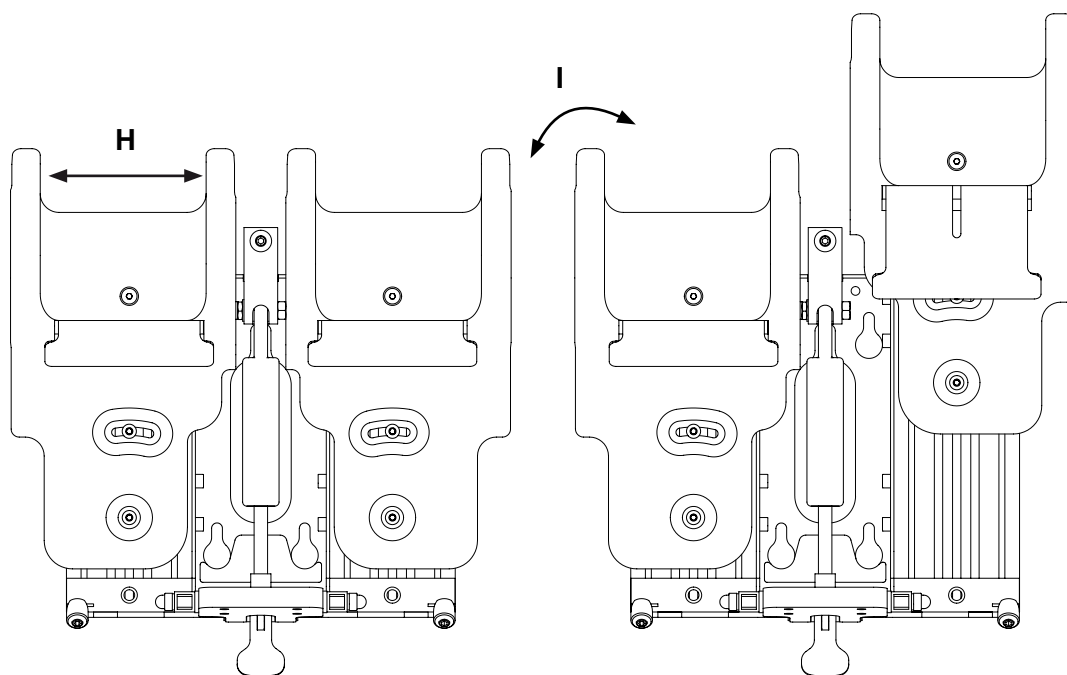

RIFERIMENTI	MISURE	0	1	2	3	4
<b>DATI UTENTE</b>						
	Peso	35 kg	50 kg	50 kg	75 kg	75 kg
	Altezza	60÷80 cm	60÷100 cm	90÷162 cm	110÷160 cm	140÷170 cm
<b>DATI SEDUTA</b>						
	Larghezza seduta	24-27-30 cm	24-27-30 cm	28-31-34 cm	32-35-38 cm	32-35-38 cm
	Profondità seduta	14÷20 cm	17÷27 cm	24÷34 cm	30÷40 cm	37÷45 cm
C	Altezza schienale	34 cm	34 cm	38,5 cm	45 cm	45 cm
D	Altezza min-max pelotte toracali	17÷27 cm	17÷27 cm	24÷34 cm	30÷40 cm	37÷45 cm
E	Larghezza schienale escluse pelotte	21 cm	21 cm	26 cm	29 cm	29 cm
	Reclinazione schienale	-12°+26°	-12°+26°	-12°+26°	-12°+26°	-12°+26°
E	Profondità supporti toracali	12 cm	12,5 cm	15 cm	17,5 cm	17,5 cm
F	Distanza (min-max) tra supporti toracali	16÷23 cm	17÷26 cm	19÷28 cm	22÷31 cm	22÷31 cm
	Altezza bracciolo	14÷20,5 cm	14÷20,5 cm	14÷20,5 cm	19÷28 cm	19÷28 cm
G	Differenza asimmetrica AA II	10 cm	10 cm	10 cm	10 cm	10 cm
	Supporto pelvico	15x70 cm	15x70 cm	15x70 cm	20x10 cm	20x10 cm
	Supporto anca	16x13 cm	16x13 cm	16x13 cm	17,5x16 cm	17,5x16 cm
	Inclinazione piede per pedana separata	0÷180°				
H	Contenimento laterale ginocchia	7 cm	9 cm	11 cm	13 cm	15 cm
I	Abduzione/adduzione arti inferiori	0°+18°	0°+18°	0°+18°	0°+18°	0°+18°
	Altezza ginocchio-pedana	16÷34 cm	16÷8 cm	16÷42 cm	16÷49 cm	16÷52 cm
	Dimensione pedana	32x26 cm	31,5x19,5 cm	34,5x22,5 cm	38x26 cm	38x31 cm
	Poggiatesta standard	22x15 cm	22x15 cm	24x19 cm	24x19 cm	24x19 cm
	Poggiatesta lungo	28x16 cm	28x16 cm	28x21 cm	28x21 cm	28x21 cm
	Misure tavolino	45x48 cm	45x48 cm	51,5x54 cm	57x57 cm	57x57 cm
	Peso unità di seduta	7 kg	9 kg	11 kg	13 kg	15 kg

# LE BASI



Pengy

Flipper

Ground per interni

Ground per esterni

Seabass PRO



BASI	PENGY	FLIPPER			GROUND PER INTERNI		GROUND PER ESTERNI		SEABASS PRO
MISURE DELFI	0/1/2	0/1	1/2	3/4	0/1/2	3/4	0/1	2	3/4
MISURE BASI	UNICA	1	2	3	1	2	1	2	UNICA
H terra-seduta	54 cm	23-61 cm			25-58 cm		41 cm		41-46 cm
Portata massima	65 kg	55 kg	75 kg	100 kg	100 kg		-	-	135 kg
Lunghezza base	95 cm	66 cm	74 cm	84 cm	68 cm	74 cm	38 cm	44 cm	70-77 cm
Larghezza base	66 cm	58 cm			52 cm	61 cm	57 cm	63 cm	60 cm
Larghezza interna	39 cm	-	-	-	-	-	-	-	40 cm
Peso base	12 kg	17 kg			16 kg		14 kg		21 kg
Basculamento	-35° a +35°	0-30°/-5°-25°			-12° +31°		-2° /-33°		0-35°/-7-28°
Piatto seduta									29x32 cm
Colore	Nero	Nero			Grigio		Grigio		Nero
Crash tested fino a	43 kg	-	-	-	-	-	-	-	-



## DOTAZIONE BASE & ACCESSORI

CODICE	NOME	MISURA	PREZZO	IVA	COD. DM	
<b>SEDUTE</b>						
<input type="checkbox"/> 285000	Zizti Delfi Pro (senza schienale)	0	2.880,00 €	4%		
<input type="checkbox"/> 285001		1	2.880,00 €	4%		
<input type="checkbox"/> 285002		2	2.880,00 €	4%		
<input type="checkbox"/> 285003		3	2.990,00 €	4%		
<input type="checkbox"/> 285004		4	2.990,00 €	4%		
<input type="checkbox"/> 285010	Schienale incl. MH	0	-	4%		
<input type="checkbox"/> 285011		1	-	4%		
<input type="checkbox"/> 285012		2	-	4%		
<input type="checkbox"/> 285013		3-4	98,00 €	4%		
<input type="checkbox"/> 285018	Schienale rinforzato incl. MH	3-4	98,00 €	4%		
<input type="checkbox"/> 285020	Supporto laterale	0	279,00 €	4%		
<input type="checkbox"/> 285021		1	279,00 €	4%		
<input type="checkbox"/> 285022		2	279,00 €	4%		
<input type="checkbox"/> 285023		3-4	279,00 €	4%		
<input type="checkbox"/> 285031	Supporto laterale pieghevole	1	398,00 €	4%		
<input type="checkbox"/> 285032		2	398,00 €	4%		
<input type="checkbox"/> 285033		3-4	398,00 €	4%		
<input type="checkbox"/> 285040	Fodera colore Nero		-	4%		
<input type="checkbox"/> 285041	Fodera colore Rosso		-	4%		
<input type="checkbox"/> 285042	Fodera colore Blu		-	4%		
<input type="checkbox"/> 285068	Supporto pelvico incl. staffe (paio)	0-1-2	298,00 €	4%		
<input type="checkbox"/> 285069		3-4	298,00 €	4%		
<input type="checkbox"/> 374060	Cintura pelvica antirotazione *	XS	106,00 € *	4%		
<input type="checkbox"/> 374061		S	106,00 € *	4%		
<input type="checkbox"/> 374063		M	106,00 € *	4%		

CODICE	NOME	MISURA	PREZZO	IVA	COD. DM	
<b>SEDUTE</b>						
<input type="checkbox"/> 990161	Contenzione laterale bacino DX o SX	1	208,00 €	4%		
<input type="checkbox"/> 990162		2	208,00 €	4%		
<input type="checkbox"/> 990163		3-4	208,00 €	4%		
<b>BASI</b>						
<input type="checkbox"/> 844303	Base da interno Flipper Pro + piastra 285171/2	0-1-2	1.199,00 €	4%		
<input type="checkbox"/> 844305	Base da interno Flipper Pro + piastra 285173	3-4	1.199,00 €	4%		
<input type="checkbox"/> V1001-1-R	Base da interni NL + piastra	0-1-2	703,00 €	4%		
<input type="checkbox"/> V1001-2-R		3-4	703,00 €	4%		
<input type="checkbox"/> VN9001-1	Base da esterno mis.1 + piastra	0-1	703,00 €	4%		
<input type="checkbox"/> VN9001-2	Base da esterno mis. 2 + piastra	2	703,00 €	4%		
<input type="checkbox"/> 386001	Base esterno Seabass Pro + piastra	3-4	1.980,00 €	4%		
<input type="checkbox"/> 385200	Pengy - Base da esterno + piastra 385242	0-1-2	1.289,00 €	4%		
<input type="checkbox"/> 153047	Piastra di montaggio universale		298,00 €	4%		
<input type="checkbox"/> 99058	Maniglia di spinta per Delfi Pro		198,00 €	4%		
<b>TAVOLINI</b>						
<input type="checkbox"/> 285141	Tavolino trasparente	1	298,00 €	4%		
<input type="checkbox"/> 285142		2	298,00 €	4%		
<input type="checkbox"/> 285143		3	298,00 €	4%		

CODICE	NOME	MISURA	PREZZO	IVA	COD. DM	
<b>POGGIATESTA</b>						
<input type="checkbox"/> 285518	Poggiatesta lungo nero, incl.MH	2	398,00 €	4%		 <p>Standard</p>  <p>Lungo</p>
<input type="checkbox"/> 285505	Poggiatesta blu, incl.MH	1	398,00 €	4%		
<input type="checkbox"/> 285506	Poggiatesta lungo blu, incl.MH	1	398,00 €	4%		
<input type="checkbox"/> 285507	Poggiatesta blu, incl.MH	2	398,00 €	4%		
<input type="checkbox"/> 285508	Poggiatesta lungo blu, incl.MH	2	398,00 €	4%		
<input type="checkbox"/> 285510	Poggiatesta rosso, incl.MH	1	398,00 €	4%		
<input type="checkbox"/> 285511	Poggiatesta lungo rosso, incl.MH	1	398,00 €	4%		
<input type="checkbox"/> 285512	Poggiatesta rosso, incl.MH	2	398,00 €	4%		
<input type="checkbox"/> 285513	Poggiatesta lungo rosso, incl.MH	2	398,00 €	4%		
<input type="checkbox"/> 285515	Poggiatesta nero, incl.MH	1	398,00 €	4%		
<input type="checkbox"/> 285516	Poggiatesta lungo nero, incl.MH	1	398,00 €	4%		
<input type="checkbox"/> 285517	Poggiatesta nero, incl.MH	2	398,00 €	4%		
<b>BRACCIOLI</b>						
<input type="checkbox"/> 285061	Bracciolo standard (paio)	1	-	4%		
<input type="checkbox"/> 285062		2	-	4%		
<input type="checkbox"/> 285063		3	-	4%		
<input type="checkbox"/> 990136	Bracciolo avvolgente	1-2	248,00 €	4%		
<input type="checkbox"/> 990137		3-4	248,00 €	4%		
<input type="checkbox"/> 285066	Supporto omerale (excl. braccioli)	UNICA	248,00 €	4%		
<b>PETTORINE</b>						
<input type="checkbox"/> 152238	PM superiore lunga per pettorina (obbligatorio se si sceglie una pettorina)	UNICA	-	4%		
<input type="checkbox"/> 3751	Pettorina sternale in pelle	XS	119,00 €	4%		
<input type="checkbox"/> 3752		S	119,00 €	4%		
<input type="checkbox"/> 3753		M	119,00 €	4%		
<input type="checkbox"/> 3754		L	119,00 €	4%		
<input type="checkbox"/> 374001	Pettorina sternale Pro in neoprene	XS	119,00 €	4%		
<input type="checkbox"/> 374002		S	119,00 €	4%		
<input type="checkbox"/> 374003		M	119,00 €	4%		
<input type="checkbox"/> 374004		L	119,00 €	4%		

CODICE	NOME	MISURA	PREZZO	IVA	COD. DM	
<b>PETTORINE</b>						
<input type="checkbox"/> 3783	Pettorina ad H in pelle	XS	119,00 €	4%		⇒ 
<input type="checkbox"/> 3784		S	119,00 €	4%		
<input type="checkbox"/> 3785		M	119,00 €	4%		
<input type="checkbox"/> 3786		L	119,00 €	4%		
<input type="checkbox"/> 374015	Pettorina ad H neoprene	XS	119,00 €	4%		
<input type="checkbox"/> 374016		S	119,00 €	4%		
<input type="checkbox"/> 374017		M	119,00 €	4%		
<input type="checkbox"/> 374018		L	119,00 €	4%		
<b>PEDANE</b>						
<input type="checkbox"/> 285070	Pedana unica, incl.MH	0		4%		⇒ 
<input type="checkbox"/> 285071		1		4%		
<input type="checkbox"/> 285072		2		4%		
<input type="checkbox"/> 285073		3		4%		
<input type="checkbox"/> 285036	Pedana con poggiatesta separati *	1	149,00 € *	4%		⇒ 
<input type="checkbox"/> 285037		2	149,00 € *	4%		
<input type="checkbox"/> 285038		3	149,00 € *	4%		
<input type="checkbox"/> 285079	Pedane separate regolabili, incl.MH *	1	198,00 € *	4%		⇒ 
<input type="checkbox"/> 285080		2	198,00 € *	4%		
<input type="checkbox"/> 285081		3	198,00 € *	4%		
<input type="checkbox"/> 281102	Distonie: adattatore flessibile pedana		198,00 €	4%		⇒ 
<input type="checkbox"/> 990041	Contenzione piede	1	298,00 €	4%		⇒ 
<input type="checkbox"/> 990042		2	298,00 €	4%		
<input type="checkbox"/> 990043		3	298,00 €	4%		
<input type="checkbox"/> 990044		4	298,00 €	4%		
<b>ACCESSORI PEDANE</b>						
<input type="checkbox"/> 285091	Imbottitura pedana unica	1	108,00 €	4%		⇒ 
<input type="checkbox"/> 285092		2	108,00 €	4%		
<input type="checkbox"/> 285093		3	108,00 €	4%		

CODICE	NOME	MISURA	PREZZO	IVA	COD. DM	
<b>ACCESSORI PEDANE</b>						
<input type="checkbox"/> 285095	Imbottitura pedana con poggiatesta separati	1	128,00 €	4%		
<input type="checkbox"/> 285096		2	128,00 €	4%		
<input type="checkbox"/> 285097		3	128,00 €	4%		
<input type="checkbox"/> 281110	Appoggia polpacci	1	238,00 €	4%		
<input type="checkbox"/> 281111	Imbottitura per appoggia polpacci	1	98,00 €	4%		
<input type="checkbox"/> 281120	Appoggia polpacci	2	238,00 €	4%		
<input type="checkbox"/> 281121	Imbottitura per appoggia polpacci	2	98,00 €	4%		
<input type="checkbox"/> 37711	Cinture per caviglie Soft	S	88,00 €	4%		
<input type="checkbox"/> 37721		M	88,00 €	4%		
<b>ACCESSORI</b>						
<input type="checkbox"/> 285156	Cuneo supporto lombare		80,00 €	4%		
<input type="checkbox"/> 152170	Struttura ludica incl. staffa		290,00 €	4%		
<input type="checkbox"/> 990070	Parasole incl. staffa		290,00 €	4%		
<b>EXTRA</b>						
	Contenzione laterale e mediale maggiorata di 4 cm, incl. imbottitura	1	Richiedi un preventivo di spesa per la personalizzazione			
		2				
		3				
<input type="checkbox"/>	Costo assemblaggio		70,00 €	4%		

\* Prezzo in aggiunta alla dotazione base. Per l'acquisto singolo richiedere un preventivo.

## NOTE

---

---

---

---

---

---

---

---

---

---

---

---



# HEADALOFT

POSTURA DEL CAPO

  
SOLUZIONI DI SUPPORTO PER LA TESTA

Fatturare a: \_\_\_\_\_

Ragionesociale: \_\_\_\_\_

Via: \_\_\_\_\_

Città: \_\_\_\_\_ C.A.P. \_\_\_\_\_

Provincia: \_\_\_\_\_

Tel. \_\_\_\_\_ Fax: \_\_\_\_\_

Spedire a: \_\_\_\_\_

\_\_\_\_\_

\_\_\_\_\_

Data ordine: \_\_\_\_\_

Num. Ordine: \_\_\_\_\_

Quantità richiesta: \_\_\_\_\_

## DESCRIZIONE

**HEADALOFT™** è una soluzione brevettata e innovativa per adulti e bambini che fanno uso di carrozzine o sedute posturali.

HEADALOFT™ sostiene piacevolmente e delicatamente la testa in posizione eretta e non restrittiva.

Adattabile a tutte le carrozzine o sedute posturali dotate di poggiatesta e seggiolini auto.

È facile da installare e può essere applicato su qualsiasi tipo di seduta dotata di un poggiatesta.

Ordine     Preventivo

Inviare l'ordine via fax. **+39 0341 360931**

o via e-mail: **ordini@creha.it**.

Per info: Tel. **+39 0341 372350**.

## CODICE RDM

 2349261

# Trattativa riservata







# HOP

SISTEMA DI POSTURA

**[FINE SERIE]**  
ultimi pezzi disponibili

Fatturare a: \_\_\_\_\_

Ragionesociale: \_\_\_\_\_

Via: \_\_\_\_\_

Città: \_\_\_\_\_ C.A.P. \_\_\_\_\_

Provincia: \_\_\_\_\_

Tel. \_\_\_\_\_ Fax: \_\_\_\_\_

Spedire a: \_\_\_\_\_

\_\_\_\_\_

\_\_\_\_\_

Data ordine: \_\_\_\_\_

Num. Ordine: \_\_\_\_\_

Quantità richiesta: \_\_\_\_\_

## DESCRIZIONE

- Braccioli
- Fianchetti
- Pedana unica senza fascette di contenimento
- Poggiatesta
- Schienale
- Cintura perlvica a 4 punti
- Base da interni o da esterni
- Bretellaggio
- Supporti tronco

Ordine     Preventivo

Inviare l'ordine via fax. +39 0341 360931

o via e-mail: [ordini@creha.it](mailto:ordini@creha.it).

Per info: Tel. +39 0341 372350.

## CODICE RDM

 1991520





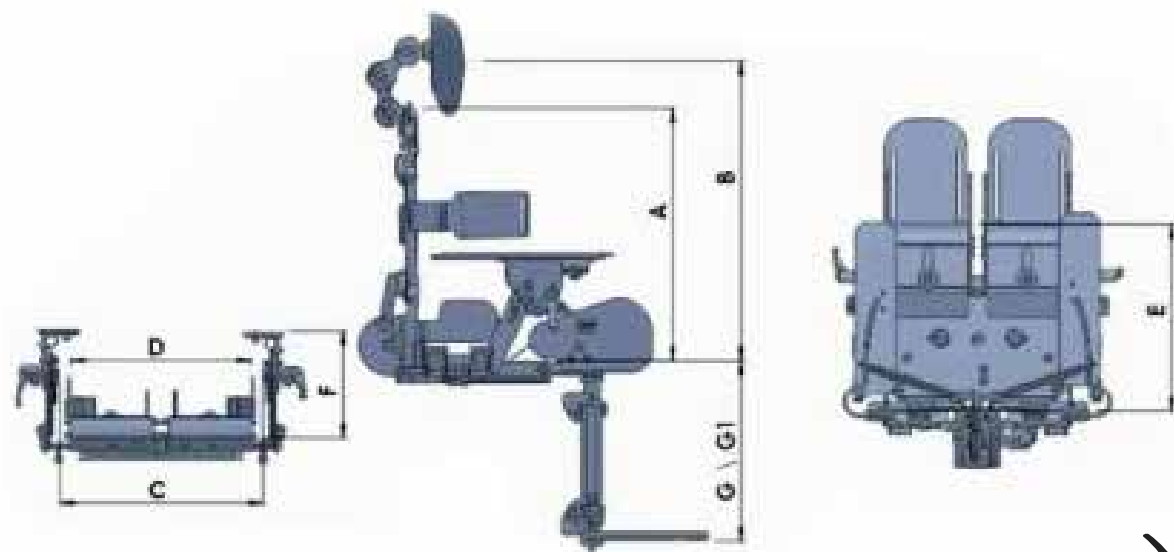



# 2.940,00 €







# MISURE HOP



RIFERIMENTO	MISURE	0	1	2
<b>DATI SEDUTA</b>				
C	Larghezza seduta fianchetti	19,5÷25,5 cm	24÷30 cm	28÷34 cm
D	Larghezza seduta- spinte posteriori	12÷22 cm	16÷26 cm	20÷32 cm
E	Profondità seduta	16÷22 cm	21÷29,5 cm	28÷36,5 cm
A	Altezza schienale	23÷28,5 cm	29,5÷37,5 cm	39÷47 cm
B	Seduta centro poggia testa	29+9 cm	33.5+9 cm	45,5+9 cm
	Altezza min-max supporti toracali	14÷24 cm	16÷30 cm	20÷35 cm
	Larghezza schienale	19,5 cm	23 cm	27 cm
	Reclinazione schienale	35°	35°	35°
	Distanza (min-max) supporti toracali	14÷20 cm	18÷24 cm	19÷29 cm
F	Altezza bracciolo	10÷12,5 cm	12,5÷17 cm	15,5÷21,5 cm
	Contenimento laterale ginocchia	06÷12 cm	09÷15 cm	dic.-18 cm
	Abduzione/adduzione arti inferiori	7,5°	17°	17°
	Inclinazione piede pedana doppia		- 8° + 35°	
G	Altezza ginocchio-pedana (doppia)	16,5÷25 cm	20,5÷30,5 cm	27,5÷37,5 cm
G1	Altezza ginocchio-pedana (unica)	11÷24 cm	12÷32 cm	21÷39 cm

## DOTAZIONE BASE & ACCESSORI

CODICE	NOME	MISURA	PREZZO	IVA	COD. DM	
<input type="checkbox"/>	Colore: Blu/Azzurro					
<input type="checkbox"/>	Colore: Rosa/Lilla					
<input type="checkbox"/> VN1014 + ASMI-7	Seduta+Schienale	0	2.940,00 €	4%		
<input type="checkbox"/> VN1015 + ASV 5		1	2.940,00 €	4%		
<input type="checkbox"/> VN1022 + ASV-72		2	2.940,00 €	4%		
<input type="checkbox"/> ASV-130-SF	Pedana Unica SF	0	-	4%		
<input type="checkbox"/> ASV-87-SF		1	-	4%		
<input type="checkbox"/> ASV-90		2	-	4%		
<input type="checkbox"/> ASV-16	Poggiatesta	1-2	-	4%		
<input type="checkbox"/> ASV-54		0	-	4%		
<input type="checkbox"/> ASV-50	Spinte bacino posteriori	0	-	4%		
<input type="checkbox"/> ASV-13-14		1	-	4%		
<input type="checkbox"/> ASV-47		2	-	4%		
<input type="checkbox"/> ASV-94	Supporto laterale tronco	0	-	4%		
<input type="checkbox"/> ASV-30-1		1	-	4%		
<input type="checkbox"/> ASV-91		2	-	4%		
<input type="checkbox"/> CB-0-T	Bretellaggio	0	-	4%		
<input type="checkbox"/> CB-1-T		1	-	4%		
<input type="checkbox"/> CB-2-T		2	-	4%		
<input type="checkbox"/> FSLT-0	Fascia supporti tronco	0	-	4%		
<input type="checkbox"/> CS-1		1	-	4%		
<input type="checkbox"/> CS-2		2	-	4%		

CODICE	NOME	MISURA	PREZZO	IVA	COD. DM	
<input type="checkbox"/> C4PT-0	Cintura pelvica 4	0	-	4%		⇒ 
<input type="checkbox"/> C4PT-1		1	-	4%		
<input type="checkbox"/> C4PT-2		2	-	4%		
<b>LA CONFIGURAZIONE BASE PREVEDE UNA SOLA SCELTA</b>						
<input type="checkbox"/> VN 1028	Base da interno	0	-	4%		⇒ 
<input type="checkbox"/> VN 1028-1		1	-	4%		
<input type="checkbox"/> VN 1028-2		2	-	4%		
<input type="checkbox"/> VN 9001	Base da esterni	0	-	4%		⇒ 
<input type="checkbox"/> VN 9001-1		1	-	4%		
<input type="checkbox"/> VN 9001-2		2	-	4%		
<input type="checkbox"/> VN 9003	Base basic	0	-	4%		⇒ 
<input type="checkbox"/> VN 9003-1		1	-	4%		
<input type="checkbox"/> VN 9003-2		2	-	4%		
<b>ACCESSORI</b>						
<input type="checkbox"/> ASV-52-C // L	Pedana separata (doppia asta) *	0	180,00 €	4%		⇒ 
<input type="checkbox"/> ASV-10-C // L		1	180,00 €	4%		
<input type="checkbox"/> ASV-73		2	180,00 €	4%		
<input type="checkbox"/> ASV-130-I	Pedana unica imbottitura *	0	130,00 €	4%		⇒ 
<input type="checkbox"/> ASV-92-L	Tavolo laminato *	0	175,00 €	4%		
<input type="checkbox"/> ASV-129-L		1-2	175,00 €	4%		
<input type="checkbox"/> FXC-0	Fascia anteriore gamba *	0	44,00 €	4%		⇒ 
<input type="checkbox"/> FXC-1		1	44,00 €	4%		
<input type="checkbox"/> FXC-2		2	44,00 €	4%		

\* La misura degli accessori scelti deve sempre coincidere con la seduta+schienale.

## NOTE



# SHARKY PRO

SISTEMA DI POSTURA



Fatturare a: \_\_\_\_\_

Ragionesociale: \_\_\_\_\_

Via: \_\_\_\_\_

Città: \_\_\_\_\_ C.A.P. \_\_\_\_\_

Provincia: \_\_\_\_\_

Tel. \_\_\_\_\_ Fax: \_\_\_\_\_

Spedire a: \_\_\_\_\_

\_\_\_\_\_

\_\_\_\_\_

Data ordine: \_\_\_\_\_

Num. Ordine: \_\_\_\_\_

Quantità richiesta: \_\_\_\_\_

## DESCRIZIONE

- Seduta con abductore regolabile lateralmente
- Cintura pelvica 4 punti
- Pedana divisa orientabile
- Braccioli regolabili in altezza, inclinazione, profondità ed intra-extra rotazione
- Schienale flessibile per distonie
- Schienale regolabile in altezza ed inclinazione
- Supporti tronco

Ordine  Preventivo

Inviare l'ordine via fax. **+39 0341 360931**

o via e-mail: [ordini@creha.it](mailto:ordini@creha.it).

Per info: Tel. **+39 0341 372350**.

## CODICE RDM

 579725

# 4.190,00 €

# MISURE SHARKY PRO

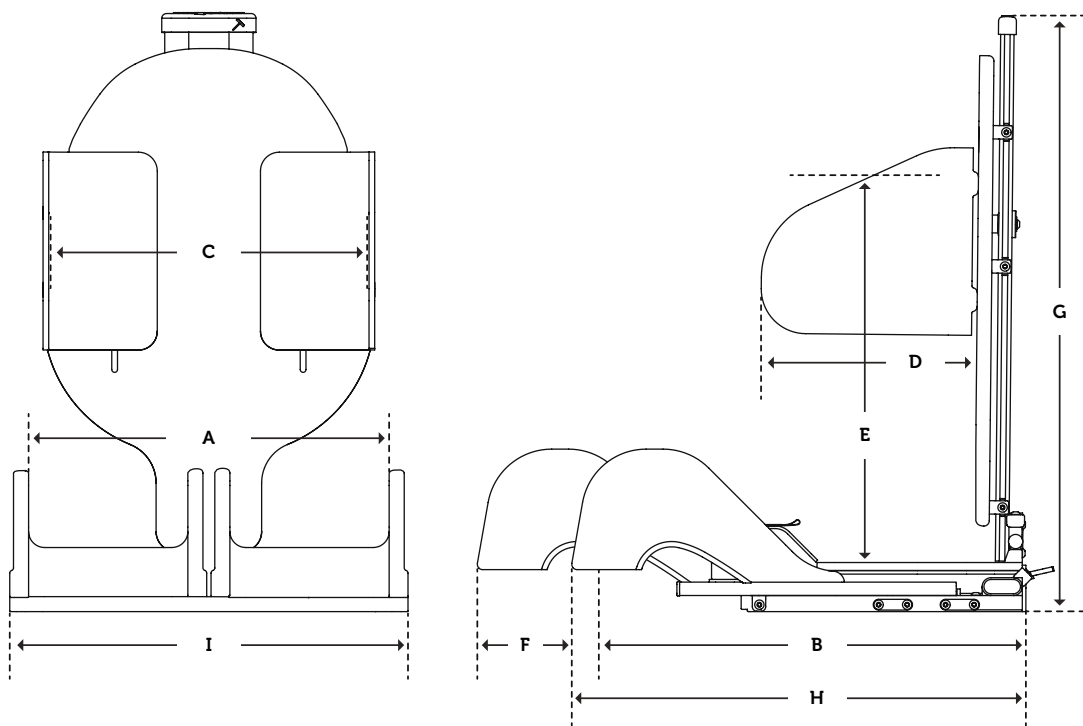

RIFERIMENTO	MISURE	1	2
<b>DATI UTENTE</b>			
	Peso	130 kg	
	Altezza	150÷180 cm	170÷195 cm
<b>DATI SEDUTA</b>			
A	Larghezza seduta	39,39,42 cm	43,46,49 cm
B	Profondità seduta	37÷47 cm	45÷55 cm
G	Altezza schienale	46÷68 cm	50÷72 cm
E	Altezza min-max pelotte toracali	35÷50 cm	40÷55 cm
	Larghezza schienale	34 cm	36 cm
	Reclinazione schienale	-10°/+25°	
C	Distanza massima tra supporti toracali	27÷35 cm	30÷38 cm
D	Profondità supporti toracali	21 cm	25 cm
F	Differenza lunghezza arti	10 cm	
	Altezza minima bracciolo	18 cm	
	Inclinazione piede	0÷180°	
	Contenimento laterale ginocchia	16 cm	18 cm
	Abduzione/adduzione AA II	18°/9°	
	Altezza ginocchio-pedana	17÷52 cm	
	Dimensione pedana	15,5 x 19 cm	16 x 22 cm
	Misure tavolino	45 x 48 cm	
H	Ingombro in lunghezza della seduta	52÷62 cm	62÷72 cm
I	Ingombro in larghezza della seduta	43,46,49 cm	50,53,56 cm
	Peso seduta	17 kg	19 kg

## BASE SEABASS PRO



BASI	SEABASS PRO
MISURE SHARKY PRO	1/2
MISURE BASE	UNICA
H terra-seduta	41÷46 cm
Portata massima	135 kg
Lunghezza base	70÷77 cm
Larghezza base	60 cm
Larghezza interna	40 cm
Peso base	21 kg
Larghezza ruote	53 cm
Basculamento	0÷35°/- 7÷28°
Piatto seduta	29x32 cm
Colore	Nero

## DOTAZIONE BASE & ACCESSORI

CODICE	NOME	MISURA	PREZZO	IVA	COD. DM	
<input type="checkbox"/> 153001	Sharky Pro (senza schienale)	1	4.190,00 €	4%	-	
<input type="checkbox"/> 153006		2	4.190,00 €	4%	-	
<input type="checkbox"/> 153010	Schienale	1		4%	-	
<input type="checkbox"/> 153015		2		4%	-	
<input type="checkbox"/> 153020	Supporto tronco (fissi)	1		4%		⇒ 
<input type="checkbox"/> 153022		2		4%		
<input type="checkbox"/> 153027	Supporto tronco pieghevoli	1	228,00 €	4%		⇒ 
<input type="checkbox"/> 153029		2	228,00 €	4%		
<b>ACCESSORI SEDUTA</b>						
<input type="checkbox"/> 153071	Supporto pelvico	UNICA	328,00 €	4%		⇒ 
<b>POGGIATESTA</b>						
<input type="checkbox"/> 153050	Poggiatesta	1	398,00 €	4%		⇒ 
<input type="checkbox"/> 153052		2	398,00 €	4%		
<b>PEDANE</b>						
<input type="checkbox"/> 153080	Pedane separate regolabili	1	-	4%	-	⇒ 
<input type="checkbox"/> 153081		2	-	4%	-	
<input type="checkbox"/> 285095	Imbottitura pedana separata	1	128,00 €	4%		⇒ 
<input type="checkbox"/> 285096		2	128,00 €	4%		



CODICE	NOME	MISURA	PREZZO	IVA	COD. DM	
<b>ACCESSORI PEDANE</b>						
<input type="checkbox"/> 281141	Appoggia polpacci	1	278,00 €	4%		
<input type="checkbox"/> 281142		2	278,00 €	4%		
<input type="checkbox"/> 281111	Imbottitura per appoggia polpacci	1	98,00 €	4%		
<input type="checkbox"/> 281121		2	98,00 €	4%		
<b>BRACCIOLI</b>						
<input type="checkbox"/> 153063	Bracciolo fisso (paio)	1-2	-	4%	/	
<b>ACCESSORI BRACCIOLI</b>						
<input type="checkbox"/> 153069	Supporto omerale	UNICA	268,00 €	4%		
<b>PETTORINE</b>						
<input type="checkbox"/> 152238	PM superiore lunga per pettorina (Obbligatorio se si acquista una pettorina)	UNICA	68,00 €	4%		
<input type="checkbox"/> 374003	Pettorina sternale Pro	M	119,00 €	4%		
<input type="checkbox"/> 374004		L	119,00 €	4%		
<input type="checkbox"/> 374017	Pettorina sternale ad H Pro	M	119,00 €	4%		
<input type="checkbox"/> 374018		L	119,00 €	4%		
<b>TAVOLINI</b>						
<input type="checkbox"/> 153073	Tavolino standard	1	338,00 €	4%		
<input type="checkbox"/> 153074		2	338,00 €	4%		
<b>BASE</b>						
<input type="checkbox"/> 153047	Piastra universale	UNICA	258,00 €	4%		

CODICE	NOME	MISURA	PREZZO	IVA	COD. DM
<b>BASE</b>					
<input type="checkbox"/> 386001	Base interno/esterno Seabass Pro + piastra	UNICA	1.980,00 €	4%	⇒ 
<b>ACCESSORI</b>					
<input type="checkbox"/> 152170	Struttura ludica incl. staffa		290,00 €	4%	⇒ 
<input type="checkbox"/> 990070	Parasole incl. staffa		290,00 €	4%	⇒ 

## NOTE

---



---



---



---



---



---



---



---



---



---



---

# SOLLEVATORI

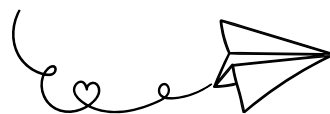

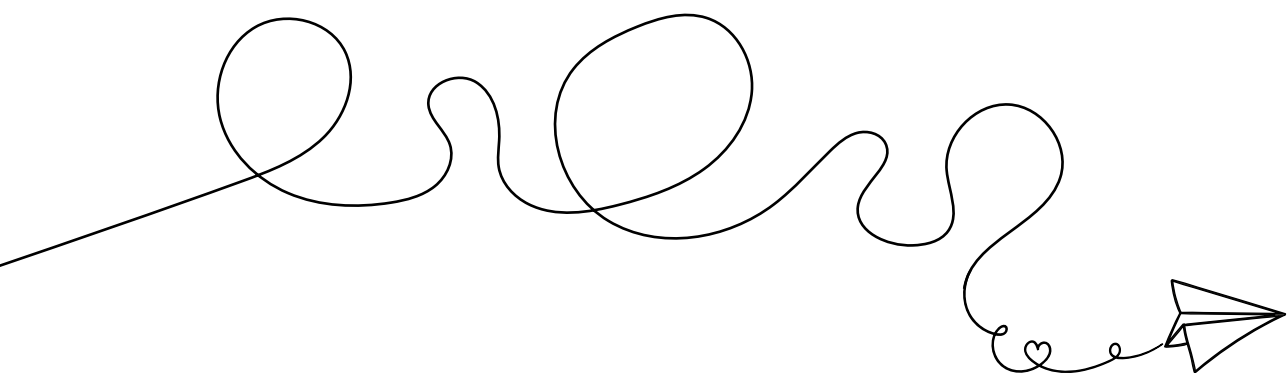



# BODY UP

SOLLEVATORE MULTIFUNZIONE

BodyUP<sup>®</sup>  
EVOLUTION THE CONCEPT OF BEING LIFTED

Fatturare a: \_\_\_\_\_

Ragionesociale: \_\_\_\_\_

Via: \_\_\_\_\_

Città: \_\_\_\_\_ C.A.P. \_\_\_\_\_

Provincia: \_\_\_\_\_

Tel. \_\_\_\_\_ Fax: \_\_\_\_\_

Spedire a: \_\_\_\_\_

\_\_\_\_\_

\_\_\_\_\_

Data ordine: \_\_\_\_\_

Num. Ordine: \_\_\_\_\_

Quantità richiesta: \_\_\_\_\_

## DESCRIZIONE

- Facile trasferimento in auto;
- Sollevamento e trasferimento dal letto ai vari ambienti della casa;
- Trasferimento sicuro su una sedia a rotelle tradizionale;
- Utilizzabile nella stanza da bagno al posto della comoda o nella doccia;
- Trasferimento su un'altra sedia o sul divano.

Ordine     Preventivo

Inviare l'ordine via fax. **+39 0341 360931**

o via e-mail: [ordini@creha.it](mailto:ordini@creha.it).

Per info: Tel. **+39 0341 372350**.

## CODICE RDM

➔ 1880695

# 2.290,00 €

## MISURE BODY UP

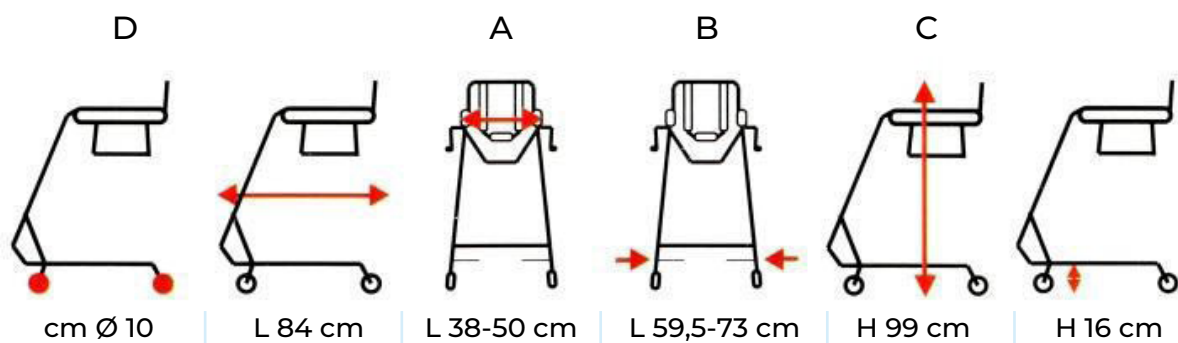

RIFERIMENTO	MISURE	UNICA
<b>DATI UTENTE</b>		
	Portata massima	100 kg
<b>DATI SEDUTA</b>		
A	Larghezza seduta	38÷50 cm
B	Larghezza min-max ausilio	61÷73 cm
C	Altezza ausilio	99 cm
D	Raggio ruote	10 cm
	Tavolino	55 x 59,5 cm

## DOTAZIONE BASE & ACCESSORI

CODICE	NOME	MISURA	PREZZO	IVA	COD. DM	
<input type="checkbox"/> BU-1000	Body UP	UNICA	2.290,00 €	4%		⇒ 
<input type="checkbox"/> BU-05	Cuscino con foro	UNICA	250,00 €	4%		⇒ 
<input type="checkbox"/> BU-09	Cuscino senza foro	UNICA	250,00 €	4%		⇒ 
<input type="checkbox"/> BU-03	Cinture stabilizzatrici	UNICA	99,00 €	4%		⇒ 
<input type="checkbox"/> BU-04	Tavolino	UNICA	98,00 €	4%		⇒ 









[www.creha.it](http://www.creha.it)

**Distribuzione in esclusiva italiana  
di articoli riabilitativi unici e di qualità**





ORTOPEDIA CASTAGNA SRL

Via Como, 1 - 23896 Bevera di Sirtori (LC)

**TELEFONO**

+39 0341 372 350

**FAX**

+39 0341 360 931

**E-MAIL**

info@creha.it

**SITO WEB**

www.creha.it